



WIRELESS REMOTE

Owner's Manual

INTRODUCTION

THANK YOU

Thank you for purchasing the Minn Kota® Advanced GPS Navigation Wireless Remote. This revolutionary control system uses GPS technology to record and store tracks and locations which are then used to deliver unprecedented levels of boat control. Intuitive features and wireless control help to accurately position your boat and improve your bait presentation. The Advanced GPS Navigation System navigates and positions your boat for you, so you can focus on fishing.

REGISTRATION

Remember to keep your receipt and immediately register your trolling motor. A registration card is included with your motor or you can complete registration on our website at minnkota.johnsonoutdoors.com/register.

PRODUCT INFORMATION (For Consumer Reference Only)

Model: _____

Serial Number: _____

Purchase Date: _____

Store Where Purchased: _____

NOTICE: Do not return your Minn Kota motor to your retailer. Your retailer is not authorized to repair or replace this unit. You may obtain service by: calling Minn Kota at (800) 227-6433; returning your motor to the Minn Kota Factory Service Center; sending or taking your motor to any Minn Kota authorized service center. A list of authorized service centers is available on our website, at minnkota.johnsonoutdoors.com. Please include proof of purchase, serial number and purchase date for warranty service with any of the above options.

Made for iPhone® 11 and iPhone X

For updated iOS, Humminbird® and Minn Kota® compatibility, visit minnkota.johnsonoutdoors.com



Use of the Made for Apple badge means that an accessory has been designed to connect specifically to the Apple product(s) identified in the badge, and has been certified by the developer to meet Apple performance standards. Apple is not responsible for the operation of this device or its compliance with safety and regulatory standards. iPhone is a trademark of Apple Inc., registered in the U.S. and other countries. The trademark “iPhone” is used in Japan with a license from Aiphone K.K. The Android™ robot is reproduced or modified from work created and shared by Google and used according to terms described in the Creative Commons 3.0 Attribution License.

SERIAL NUMBER

Your Minn Kota 11-character serial number is very important. It helps to determine the specific model and year of manufacture. When contacting Consumer Service or registering your product, you will need to know your product’s serial number. We recommend that you write the serial number down so that you have it available for future reference.

NOTICE: The motor serial number encompasses the Advanced GPS Navigation System. The location of the serial number is in a different location based on the motor model it is installed on. Refer to the images to the right to determine location based on motor model.

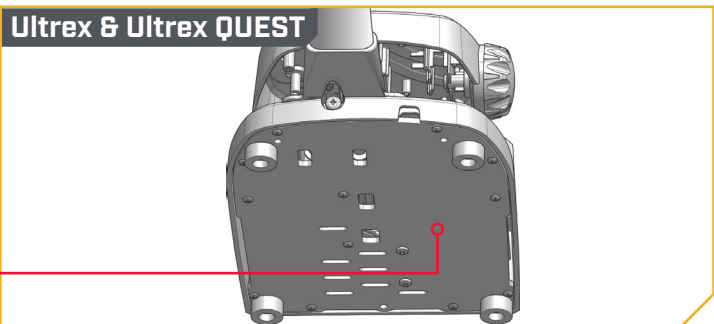
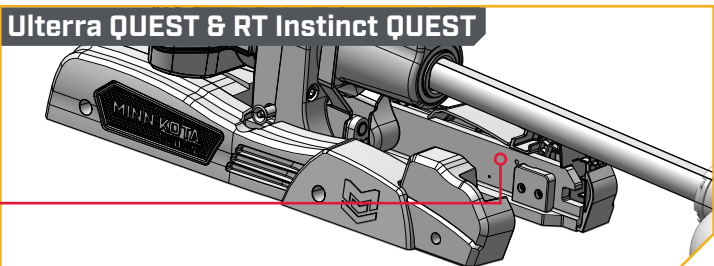
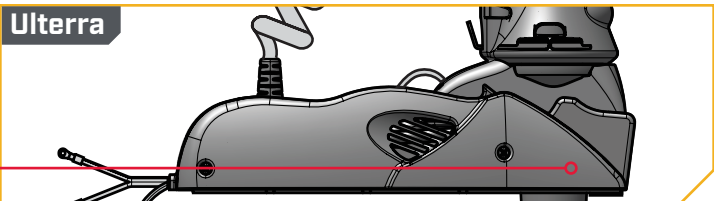
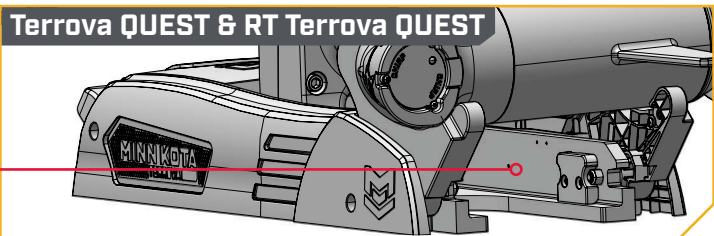
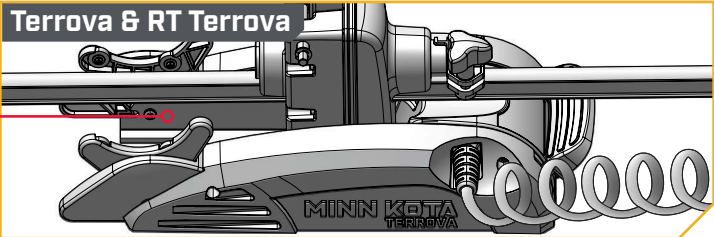
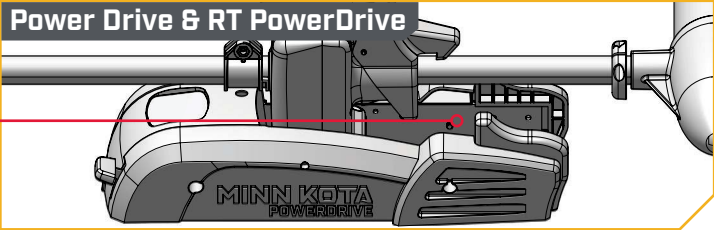

Made by Minn Kota Johnson Outdoors Marine Electronics, Inc. 121 Power Drive Mankato, MN 56001 USA Trolling Motors Produced in XXXX	PRODUCT DESCRIPTION MODEL XXXXXXXX	XXV DC XX A
	SER NO YYDDDC00000	
	EXAMPLE	

TABLE OF CONTENTS

SAFETY CONSIDERATIONS	5	FOLLOW THE CONTOUR	80
WARRANTY	6	Change the Offset with Follow the Contour.....	81
FEATURES	7	Reverse Direction with Follow the Contour.....	81
REMOTE BUTTONS	8	Disengage Follow the Contour	82
DISPLAY SCREEN	9	FOLLOW THE SHORELINE	83
REMOTE NAVIGATION	14	Change the Offset with Follow the Shoreline.....	84
Menu Button.....	14	Reverse Direction with Follow the Shoreline.....	84
Menu Options	15	Disengage Follow the Shoreline	85
Power Button.....	24	ROUTES	86
GETTING STARTED	25	Reverse the Direction of Route Navigation.....	87
The Advanced GPS Navigation System.....	25	Disengage Route Navigation	87
System Startup.....	27	MY DATA	88
Connect the Advanced GPS Navigation System to		Viewing Spot-Locks.....	88
the Humminbird.....	27	Deleting a Spot-Lock.....	88
Powering up the Advanced GPS Navigation System.....	28	Viewing Waypoints	89
Powering Off the Wireless Remote.....	29	Deleting a Waypoint	89
Changing the Remote Battery	30	Viewing iTracks.....	90
Understanding Audio Modes.....	31	Deleting an iTrack.....	90
HEADING SENSOR	33	Sorting My Data	91
ONE-BOAT NETWORK	36	Memory Full.....	91
One-Boat Network Overview	36	Restoring My Data	92
Customizing the OBN Buttons on the Wireless Remote.....	37	MOTOR CONTROLS	93
Customizing the OBN Button on the Foot Pedal.....	40	To Toggle the Prop Auto On	93
One-Boat Network Adjustments.....	42	Setting the Keel Mount Offset.....	94
SPOT-LOCK	47	To Toggle Straight on Deploy	95
Engaging Spot-Lock	48	To Toggle Dodge.....	95
Disengaging Spot-Lock	49	Change the Arrival Mode.....	96
Spot-Lock Jog.....	50	To Toggle Eco Mode	97
Go To a Saved Spot-Lock.....	51	To Turn on Battery Notifications	98
Disengage Go To Spot-Lock.....	51	To Adjust Motor LED Brightness	98
DRIFT MODE	52	Adjusting Boat Scale	99
Engaging Drift Mode	53	Setting the Stow Orientation.....	99
Disengaging Drift Mode.....	53	Setting the Heading Sensor Calibration	100
Drift Mode Adjusting Course - Angle.....	54	Setting Heading Offset	101
Drift Mode Jog.....	54	Deploying the Motor.....	103
Reverse Drift Mode	55	Stowing the Motor.....	104
DODGE MODE	56	Adjusting the Trim.....	105
Turning Dodge Mode On/Off	57	SHALLOW WATER ANCHOR CONTROLS	107
Engaging and Disengaging Dodge Mode.....	57	Talon Control	107
WAYPOINTS	58	Raptor Control	110
Mark a Waypoint	59	REMOTE CONTROLS	114
Go To a Saved Waypoint	60	To Adjust the Backlight	114
Disengaging Go To Waypoint	61	To Adjust the Backlight Timeout.....	114
CRUISE CONTROL	62	To Adjust the Theme	115
Engaging Cruise Control.....	63	Selecting Remote Language.....	115
Disengaging Cruise Control	63	Change the Distance Units.....	116
MAX SPEED	64	Change the Depth Units.....	117
Engaging Max Speed.....	65	Change the Speed Units.....	117
Disengaging Max Speed	65	Change the Temperature Units.....	118
AUTOPILOT	66	Change the Time Format	119
AutoPilot Modes	66	Change the Time Zone	119
Engaging AutoPilot	67	Toggle Daylight Savings.....	120
To Set the Default AutoPilot Mode.....	68	Change Power Off Time.....	121
AutoPilot Adjust Course - Angle.....	69	SERVICE & MAINTENANCE	122
AutoPilot Adjust Course - Jog for Locked		To Open the Diagnostic Screen.....	122
Course AutoPilot	69	View Error Codes.....	122
Disengaging AutoPilot.....	70	Restore System Defaults	125
ITRACKS	71	Advanced GPS Navigation System Software	126
Recording an iTrack Using the OBN Button	72	To Open the About Screen.....	126
Recording an iTrack Using the Menu Button.....	73	Update Wireless Remote Software	127
Go To a Saved iTrack Using the OBN Button	74	Pairing a Remote with a Controller.....	129
Disengage Go To iTrack.....	76	Talon with the Advanced GPS Navigation System	130
Go To a Saved iTrack Using the Menu Button.....	75	Raptor with the Advanced GPS Navigation System	131
Reverse Go To iTrack.....	76	Bluetooth Device List	132
CIRCLE MODE	77	General Maintenance	134
Change the Radius of Circle Mode.....	78	Troubleshooting.....	134
Reverse Direction with Circle Mode.....	78	For Further Troubleshooting and Repair.....	135
Disengage Circle Mode	79	COMPLIANCE STATEMENTS	136
		PARTS DIAGRAM & PARTS LIST	138

SAFETY CONSIDERATIONS

Please thoroughly read the user manual. Follow all instructions and heed all safety and cautionary notices. Use of this product is only permitted for persons that have read and understood these user instructions. Minors may use this product only under adult supervision.

WARNING

You are responsible for the safe and prudent operation of your vessel. We have designed your Minn Kota product to be an accurate and reliable tool that will enhance boat operation and improve your ability to catch fish. This product does not relieve you from the responsibility for safe operation of your boat. You must avoid hazards to navigation and always maintain a permanent watch so you can respond to situations as they develop. You must always be prepared to regain manual control of your boat. Learn to operate your Minn Kota product in an area free from hazards and obstacles.

CAUTION

This unit uses a magnetic compass to detect direction of travel. The compass can be adversely affected by magnets or large, ferrous metal objects near (within 24" of) the trolling motor control head.

Obstructions on the propeller may cause excessive vibration of the motor head. This vibration can cause the compass to wander and erratic steering to occur. Clear the obstruction to return the motor and Advanced GPS Navigation System to normal operation.

WARNING

It is recommended to only use Johnson Outdoors approved accessories with your Minn Kota motor, such as this Minn Kota Advanced GPS Navigation Wireless Remote. Using non-approved accessories to mount or control your motor may cause damage, unexpected motor operation and injury. Be sure to use the product and approved accessories, including remotes, safely and in the manner directed to avoid accidental or unexpected motor operation. Keep all factory installed parts in place including motor and accessory covers, enclosures and guards.

WARNING

When the motor is being controlled by the Wireless Remote, the Control Head will continue to perform the last task it was assigned, even when the remote is not powered "on." Be sure to know how to power the motor "on" and "off", and always be alert for unexpected motor movement, such as a turning propeller, even when the remote is powered "off." Refer to the Owner's Manual for how to control the motor without the Wireless Remote and become familiar with its features including how to turn it "on" and "off."

WARRANTY

WARRANTY ON MINN KOTA ADVANCED GPS NAVIGATION TROLLING SYSTEM ACCESSORY

LIMITED TWO-YEAR WARRANTY ON ENTIRE PRODUCT

Johnson Outdoors Marine Electronics, Inc. (“JOME”) extends the following limited warranty to the original retail purchaser only. Warranty coverage is not transferable.

Minn Kota Limited Two-Year Warranty on the Entire Product

JOME warrants to the original retail purchaser only that the purchaser’s new Advanced GPS Navigation Trolling System Accessory will be materially free from defects in materials and workmanship appearing within two (2) years after the date of purchase. JOME will (at its option) either repair or replace, free of charge, any parts found by JOME to be defective during the term of this warranty. Such repair, or replacement shall be the sole and exclusive liability of JOME and the sole and exclusive remedy of the purchaser for breach of this warranty.

EXCLUSIONS AND LIMITATIONS

This limited warranty does not apply to products that have been used commercially or for rental purposes. This limited warranty does not cover normal wear and tear, blemishes that do not affect the operation of the product, or damage caused by accidents, abuse, alteration, modification, shipping damages, acts of God, negligence of the user or misuse, improper or insufficient care or maintenance. **DAMAGE CAUSED BY THE USE OF OTHER REPLACEMENT PARTS NOT MEETING THE DESIGN SPECIFICATIONS OF THE ORIGINAL PARTS WILL NOT BE COVERED BY THIS LIMITED WARRANTY.** The cost of normal maintenance or replacement parts which are not in breach of the limited warranty are the responsibility of the purchaser. Prior to using products, the purchaser shall determine the suitability of the products for the intended use and assumes all related risk and liability. Any assistance JOME provides to or procures for the purchaser outside the terms, limitations or exclusions of this limited warranty will not constitute a waiver of the terms, limitations or exclusions, nor will such assistance extend or revive the warranty. JOME will not reimburse the purchaser for any expenses incurred by the purchaser in repairing, correcting or replacing any defective products or parts, except those incurred with JOME’s prior written permission. **JOME’S AGGREGATE LIABILITY WITH RESPECT TO COVERED PRODUCTS IS LIMITED TO AN AMOUNT EQUAL TO THE PURCHASER’S ORIGINAL PURCHASE PRICE PAID FOR SUCH PRODUCT.**

Minn Kota Service Information

To obtain warranty service in the U.S., the product believed to be defective, and proof of original purchase (including the date of purchase), must be presented to a Minn Kota Authorized Service Center. Go to <https://minnkota.johnsonoutdoors.com/us/support/service-providers/locate> to find a Minn Kota Authorized Service Center. Any charges incurred for service calls, transportation or shipping/freight to/from the Minn Kota Authorized Service Center, labor to haul out, remove, re-install or re-rig products removed for warranty service, or any other similar items are the sole and exclusive responsibility of the purchaser. Products purchased outside of the U.S. must be returned prepaid with proof of purchase (including the date of purchase and serial number) to any Authorized Minn Kota Service Center in the country of purchase. To contact Minn Kota Customer Service go to <https://minnkota-help.johnsonoutdoors.com>. **Products repaired or replaced will be warranted for the remainder of the original warranty period, or for 90 days from the date of repair or replacement, whichever is longer. For any product that is returned for warranty service that JOME finds to be not covered by or not in breach of this limited warranty, there will be a billing for services rendered at the prevailing labor rate of the applicable Minn Kota Authorized Service Center and for a minimum of at least one hour.**

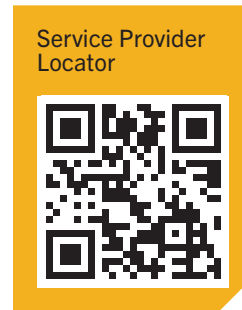

Service Provider Locator

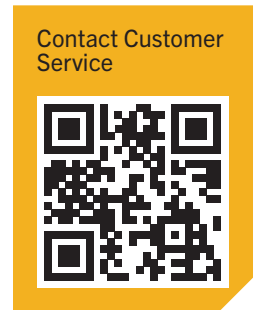

Contact Customer Service

NOTICE: Do not return your Minn Kota product to your retailer. Your retailer is not authorized to repair or replace products.

NOTICE: THERE ARE NO EXPRESS WARRANTIES OTHER THAN THESE LIMITED WARRANTIES. IN NO EVENT SHALL ANY IMPLIED WARRANTIES INCLUDING ANY IMPLIED WARRANTIES OF MERCHANTABILITY OR FITNESS FOR PARTICULAR PURPOSE, EXTEND BEYOND THE DURATION OF THE RELEVANT EXPRESS LIMITED WARRANTY. IN NO EVENT SHALL JOME BE LIABLE FOR PUNITIVE, INDIRECT, INCIDENTAL, CONSEQUENTIAL OR SPECIAL DAMAGES. Without limiting the foregoing, JOME assumes no responsibility for loss of use of product, loss of time, inconvenience or other damage.

Some states do not allow limitations on how long an implied warranty lasts or the exclusion or limitation of incidental or consequential damages, so the above limitations and/or exclusions may not apply to you. This warranty gives you specific legal rights and you may also have other legal rights which vary from state to state.

FEATURES

MINN KOTA WIRELESS REMOTE

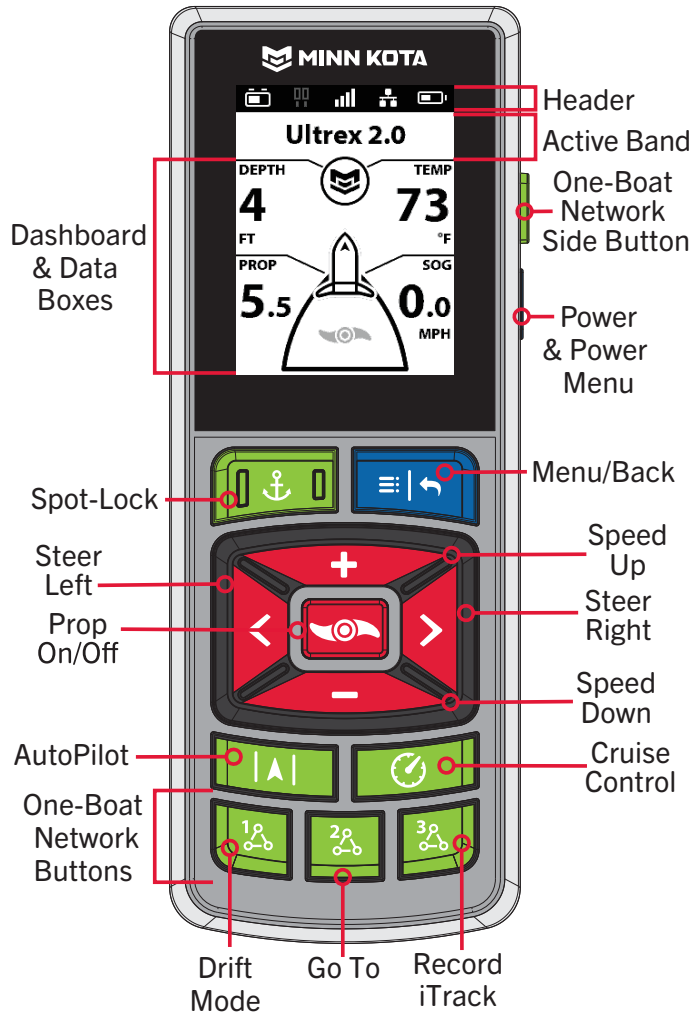

ADVANCED GPS NAVIGATION SYSTEM ON MOTOR CONTROL HEAD

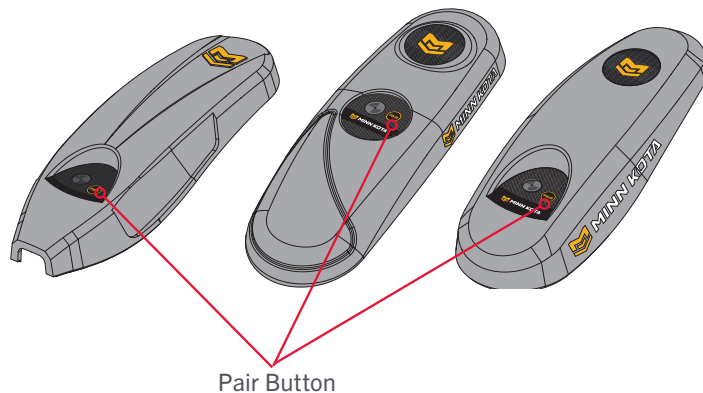

NOTICE: Specifications subject to change without notice. This diagram is for reference only and may differ from your actual product.

REMOTE BUTTONS

MENU CONTROL >

 **Power**
Press to turn remote on. During operation, press once for power and lighting menu options and SWA and motor controls. Press and hold for 3 seconds to power off.



 **Menu/Back**
Press to move in or out of menu(s). **Press and hold to close menu(s) and return to Dashboard.**

MANUAL CONTROL >

 **Speed Up & Speed Down**
Press to increase or decrease motor speed. Press to scroll up and down in a menu.

 **Steer Left & Steer Right**
Press to steer the motor to the left or to the right. Press to move left or right in a menu.

 **Prop On/Off**
Press to turn the Prop on and off.

NOTICE: If Steer Right  or Steer Left  is held down for more than eight seconds, the steering will stop to prevent the coil cord from wrapping around the shaft.





NAVIGATION >

 **Spot-Lock**
Press to enable and disable Spot-Lock.

 **AutoPilot**
Press to enable and disable AutoPilot.

 **Cruise Control**
Press to enable and disable Cruise Control.

 **One-Boat Network**
Press to enable and disable One-Boat Network (OBN) functions.

NOTICE: QUEST series trolling motors, such as the Minn Kota RT Instinct QUEST, Terrova QUEST, and Ultrex QUEST, will have a built-in heading sensor. Non-QUEST series trolling motors such as the Minn Kota Terrova, PowerDrive, Ulterra and Ultrex may be paired with an external heading sensor. If the motor is connected to a Heading Sensor, the Speed Down  (backwards), Speed Up  (forward), Steer Right  (right) and Steer Left  (left) buttons function change to Jog the boat while in Spot-Lock.

NOTICE: The remote is waterproof, but will not float.

DISPLAY SCREEN

DISPLAY SCREEN

The Display Screen consists of the Header, Active Band, Dashboard and Data Boxes. The information shown on the Display Screen changes based on the menu selections and connected devices.

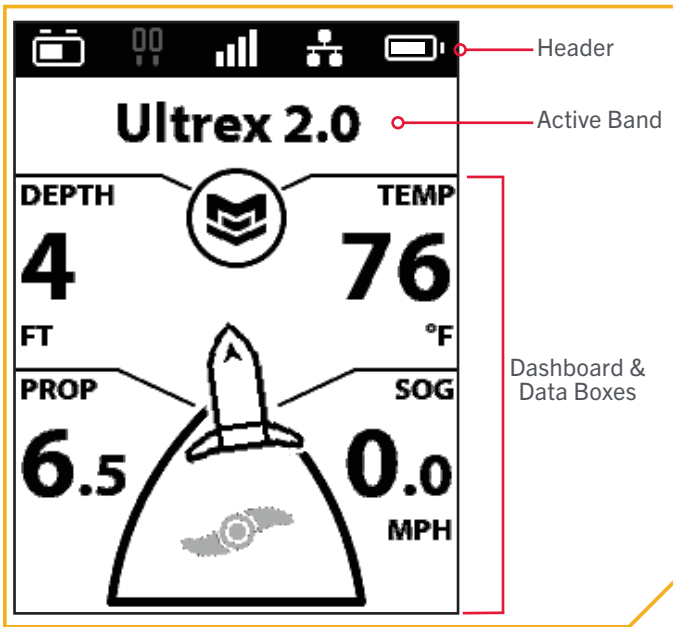

HEADER >

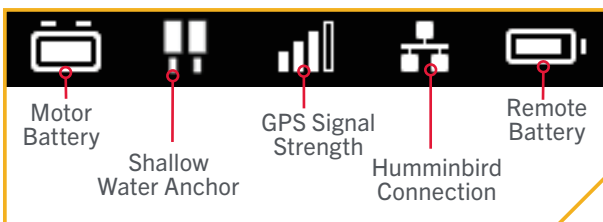

NOTICE: Grey icons indicate there is no connection. If a Humminbird or a Shallow Water Anchor have never been connected, the icon will not appear.

	Motor Battery	Battery level when prop is disengaged. ◆ ■
	Shallow Water Anchor	Displays the connection with one or two Shallow Water Anchors (SWA).
	GPS Signal Strength	Displays the level of GPS signal strength. If no bars appear, or the bars are flashing, the system has not yet acquired a GPS fix.
	Humminbird Connection	Displays white when Humminbird is connected.
	Remote Battery	Displays the battery level of the remote.

◆ Only available on QUEST series trolling motors. ■ Only available on select trolling motors.

DISPLAY SCREEN



DASHBOARD AND DATA BOXES

The Data Boxes on the Dashboard are specific to navigational functions and menus. Depth, Temperature, Prop Speed and Speed Over Ground (SOG) are common Data Boxes. Other Data Boxes appear when appropriate for the selected navigational functions.

Data Boxes

DEPTH	Depth	Current water depth based on communication with a Humminbird.	TARGET	Target Speed	Target Speed when Cruise Control is enabled.
TEMP	Temperature	Current water temperature based on communication with a Humminbird.	COURSE	Course	Intended direction of travel measured between the start point and end point.
PROP	Prop Speed	Displays the current Prop Speed.	CONTOUR	Contour	Designated depth selected when Following the Contour.
	Prop On/Off	Displays when Prop is enabled. Rotates when the Prop is on and the Prop Speed is greater than zero. Blinks when a mode of navigation is used that requires the prop to be enabled.		Record	Displays when recording an iTrack.
	Motor Heading	Direction that the motor is pointing in relation to the Keel.	JOG	Spot-Lock Jog	Displays when Spot Lock is engaged and the motor is Spot-Lock Jog enabled.
SOG	Speed Over Ground	Displays the current speed over ground.	RADIUS	Radius	Displays when using Circle Mode. Radius is a distance from the set point.
	Max Speed	Displayed when Max Speed is enabled.	BRG	Bearing	The direction from the boat's current location to the target destination during navigation.
DIST	Distance	Distance to a Go To mode of navigation.	DTG	Distance To Go	Distance to go to a Spot-Lock.
				Eco	Eco mode saves battery life by limiting thrust on select models.

Only available on QUEST series trolling motors.



› Sample Dashboard and Data Boxes

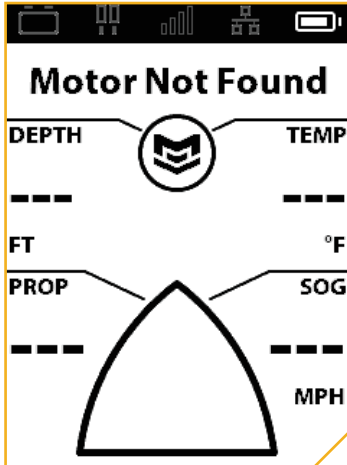

› Motor Not Found

The remote is not paired to a motor, the paired motor is out of range, or the paired motor is not powered on.

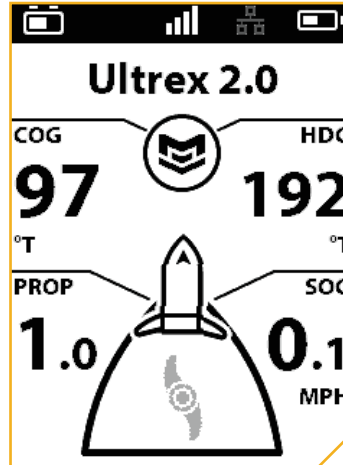

› No Humminbird Connection

When a compatible Humminbird fish finder is not connected with the motor. The Dashboard display is showing Course Over Ground (COG) and Motor Heading (HDG).

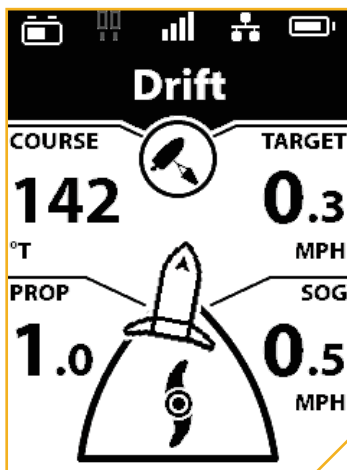

› Navigation Mode

When the Advanced GPS Navigation System is in a Navigation Mode (Drift), the Active Band at the top of the Dashboard displays the Navigation Mode in use and the Data Boxes are updated based on the mode displayed.

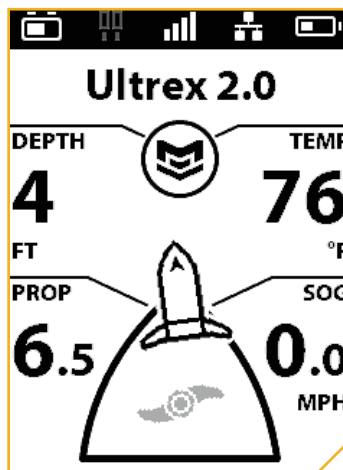

› Manual Mode

When the Wireless Remote is paired to the motor and also connected to a Humminbird, but no navigation modes have been engaged. When in Manual Mode, the user can turn the Prop "on" and "off," enter prop speed, and manually steer.

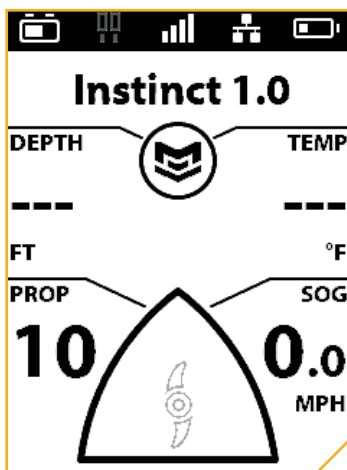

› Prop Lock Out

The Prop icon turns grey when in prop lockout. Conditions for prop lockout vary by trolling motor model.

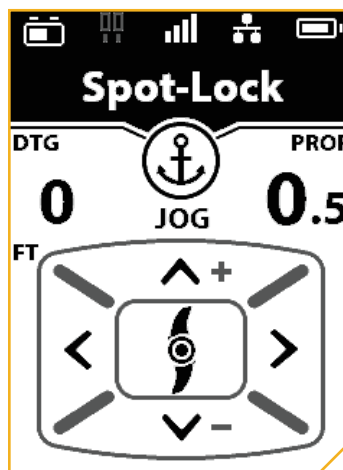

› Jog

When Spot-Lock is active, the Jog feature becomes available and the Dashboard displays the manual control options. A Heading Sensor is required for Spot-Lock Jog.

DISPLAY SCREEN

ACTIVE BANDS >

Active Bands appear on the Minn Kota Wireless Remote any time a navigational function is engaged. They are designed to tell more about how the system is functioning and display information to the user that is helpful in navigation. Active Bands are slightly different depending on the type of navigation that is being executed. When not in a navigational function, the Active Band displays the motor name. Become familiar with the most common Active Bands.



Locked Heading AutoPilot

Appears when AutoPilot is engaged and the AutoPilot Mode is set to Locked Heading.



Locked Course AutoPilot

Appears when AutoPilot is engaged and the AutoPilot Mode is set to Locked Course.



Drift

Appears when Drift is engaged.



Spot-Lock

Appears when Spot-Lock is engaged.



Dodge

Appears when Dodge is engaged.



Go To iTrack

Appears when an iTrack is being navigated.



Go To Waypoint

Appears when you follow a route or Go To a Waypoint.



Go To Route

Appears when a Route is being navigated. Initiated by the Humminbird.



Follow the Contour

Appears when Follow the Contour is being navigated. Initiated by the Humminbird.



Follow the Shoreline

Appears when Follow the Shoreline is being navigated. Initiated by the Humminbird.



Circle Mode

Appears when Circle Mode is being navigated. Initiated by the Humminbird.

Sample Active Bands

Become familiar with some of the Active Bands used on the Wireless Remote.

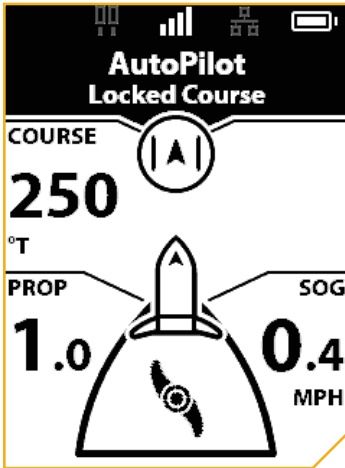

The AutoPilot Locked Course Active Band appears when Locked Course AutoPilot is engaged.

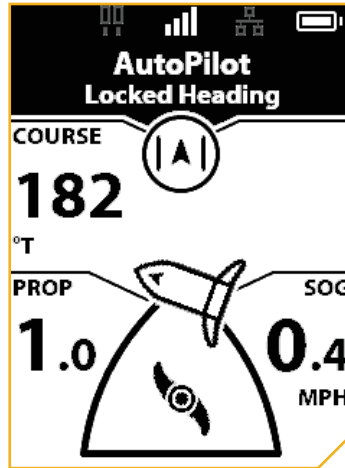

The AutoPilot Locked Heading Active Band appears when Locked Heading AutoPilot is engaged.

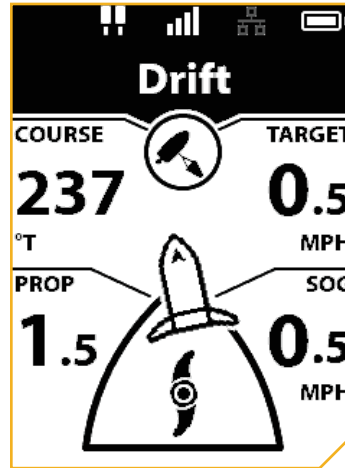

The Drift Active Band appears when the boat is navigating in Drift Mode.

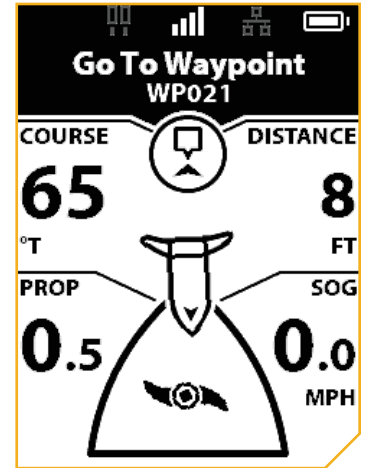

The Go To Waypoint Active Band appears when the boat is navigating to a saved Waypoint. The Waypoint is eight feet away.

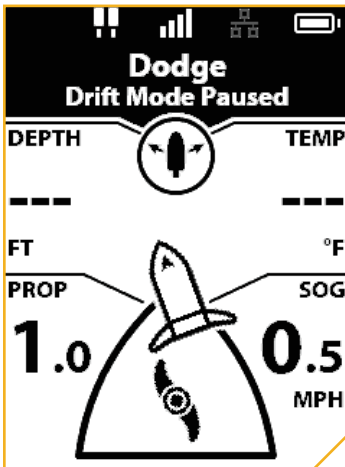

The Dodge Active Band appears when Dodge is activated and the current navigation mode is paused.

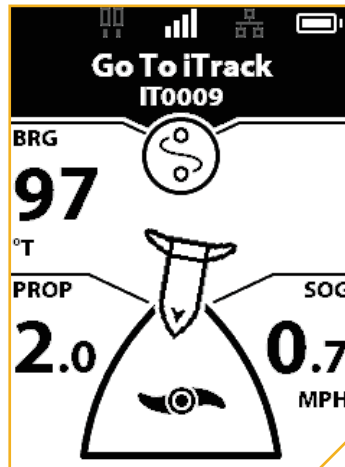

The iTrack Active Band appears when a Go To iTrack action is taking place.

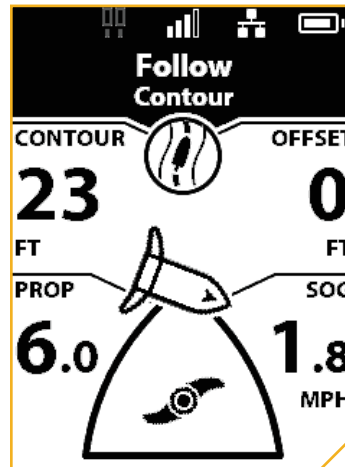

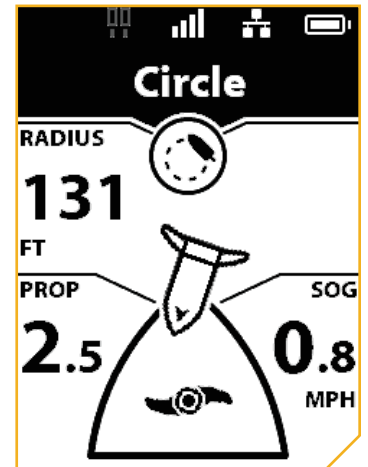

The Follow the Contour Active Band appears when the boat is navigating with Follow the Contour. The Contour being followed is 23 feet. The Offset is set to zero feet.







The Circle Mode Active band appears when the navigation is set to Circle Mode. The current circle radius is set to 131 feet.

REMOTE NAVIGATION



USING THE WIRELESS REMOTE

The Wireless Remote is equipped with buttons on the bottom half and right side of the remote. Menus within the remote system can be navigated using the Menu  button and Manual Control buttons. Many of the menus require the user to scroll up and down to view additional options. Arrows are present when any menu has a submenu. Press the Steer Right  button to display the submenu.

MENU BUTTON

When using the remote buttons, the Menu  button will open the Motor Menu. The Speed Up , Speed Down  buttons are used to move up and down the Motor Menu and the Steer Right  button is used to select an option.

The selected menu is highlighted in black (Light mode) or yellow (Dark mode). See Remote Preferences > Change the Theme for more information on changing the background theme.

To return to the Dashboard, press and hold the Menu  button. To go back one menu screen, press the Menu  button once.

NOTICE: Some menus may be grayed out or not appear on the remote. There are a number of reasons a menu may not be displayed, including the remote not being paired or communicating with the controller, a GPS fix has not been made, the motor is stowed, or the Prop is locked out.

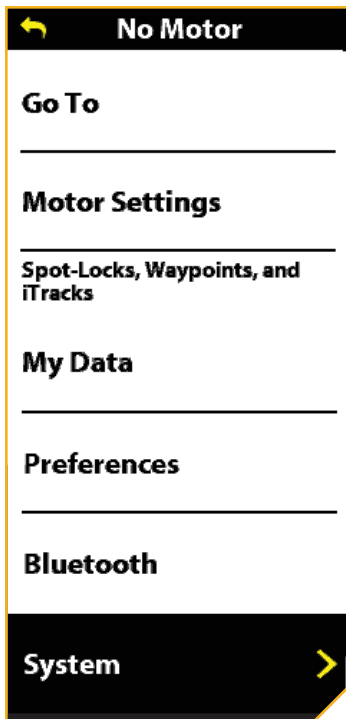

The remote is in Light mode. The remote is not connected to a motor. Some of the menu functions are not available. The selected menu is highlighted in black and is available.

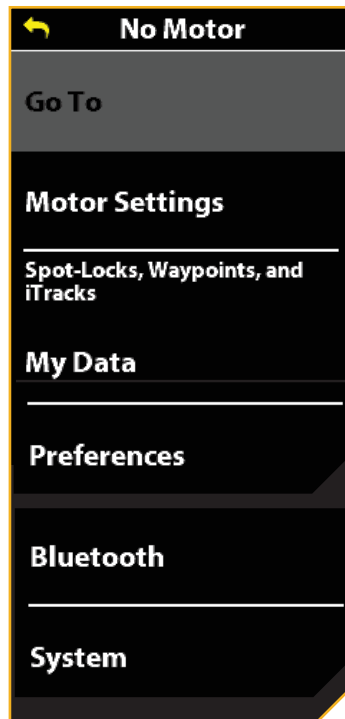

The remote is in Dark mode. The remote is not connected to a motor. Some of the menu functions are not available. The selected menu highlighted in gray is not available.

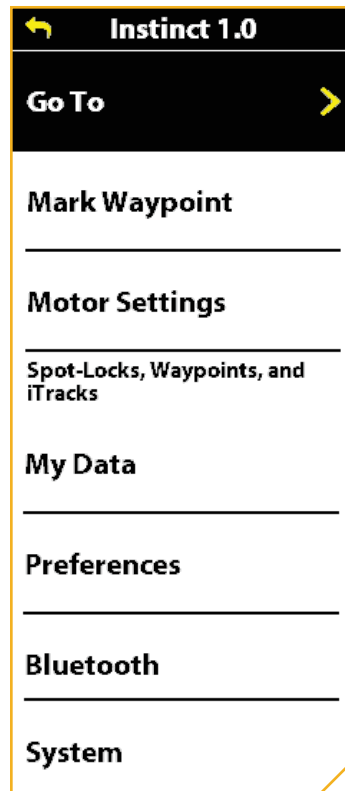

The remote is in Light mode. The selected menu is highlighted in black. The arrow indicates an active menu item. The remote is connected to a motor, so additional menu options, like Mark Waypoint, appear.

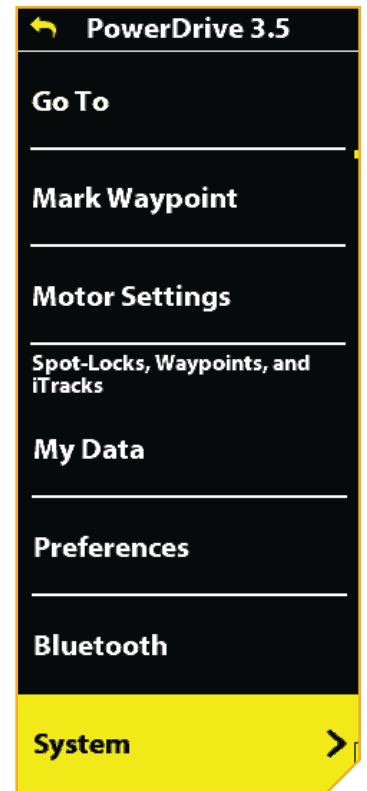

The remote is in Dark mode. The selected menu is highlighted in yellow. The arrow indicates an active menu item. The remote is connected to a motor, so additional menu options, like Mark Waypoint, appear.

MENU OPTIONS

Become familiar with the Menu options to easily navigate controls within the Wireless Remote.

› Motor Menu

The Motor Menu is accessible by pressing the Menu  button. Become familiar with the choices in the Motor Menu to better customize the Wireless Remote. Selections change depending on if a motor is connected.

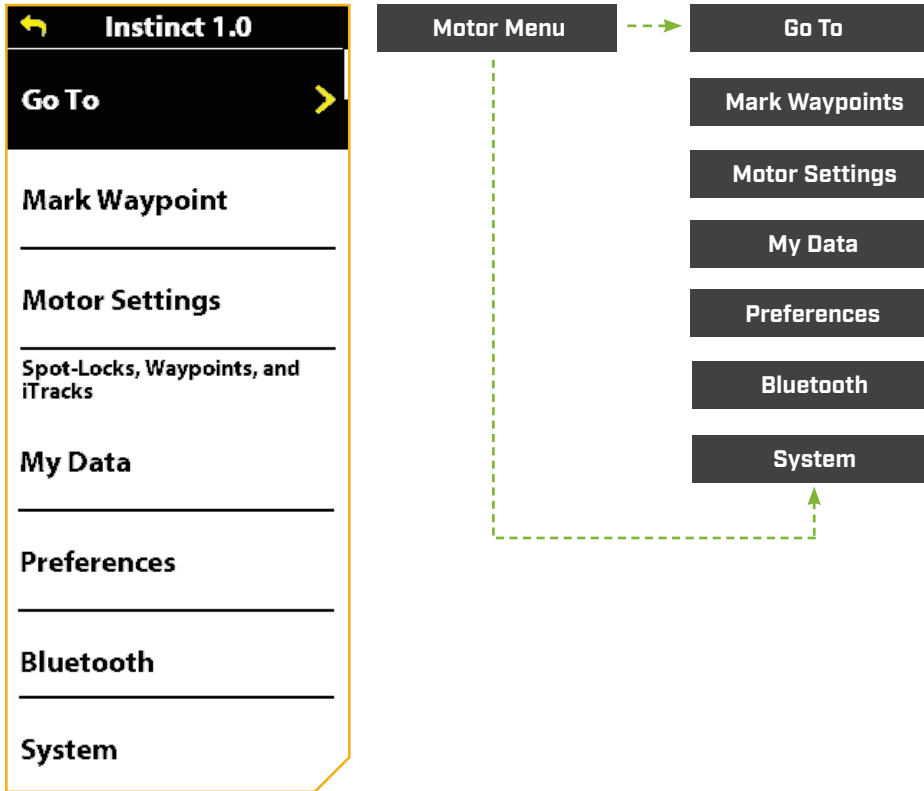

GO TO - Use this menu to navigate to a Spot-Lock, Waypoint, iTrack or initiate Drift Mode.

MARK WAYPOINTS - Use this menu to mark a Waypoint.

MOTOR SETTINGS - Use this menu to configure the motor, such as AutoPilot Mode, Arrival Mode, Prop Auto On, Straight On Deploy, Dodge and Setup. Customize the One-Boat Network (OBN) buttons.

MY DATA - Use this menu to view saved navigation data, including Spot-Locks, Waypoints and iTracks.



PREFERENCES - Use this menu to adjust preferences such as background display theme, units of measurement, language and time zone.

BLUETOOTH - Use this menu to pair any new devices or to review devices currently connected to the network.

SYSTEM - Use this menu to view information about the Wireless Remote, including software updates and error codes.

REMOTE NAVIGATION

› Go To Menu

The Go To Menu is accessed by pressing the Menu  button. Go To Menu selections include Go To Spot-Locks, Go To Waypoints, Go To iTracks, and Go To Drift. The OBN 2  button opens the Go To Menu by default.

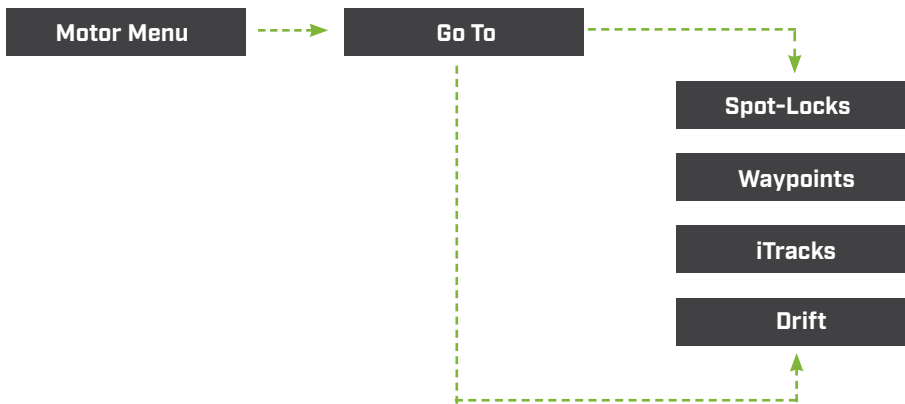
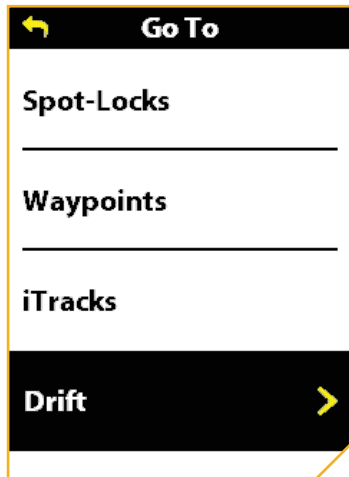

SPOT-LOCKS - Use this menu to navigate to a saved Spot-Lock.

WAYPOINTS - Use this menu to navigate to a saved Waypoint.

ITRACKS - Use this menu to navigate to a saved iTrack.

DRIFT - Use this menu to initiate Drift Mode.

› Motor Settings Menu

The Motor Settings Menu is accessed by pressing the Menu  button. Various motor settings and Advanced GPS Navigation functions can be configured through the Motor Settings menu, including Autopilot Mode, Arrival Mode, Prop Auto On, Straight on Deploy, Dodge and Setup/Calibration. Use this menu to customize your One-Boat Network (OBN) buttons. Other features, such as Eco Mode, Battery Full and Low notifications, Audio Mode and Motor LED Brightness, can also be configured from this menu. Select features are model specific. Eco Mode, Battery Notifications, Straight on Deploy, and Motor LED Brightness are only available on QUEST series trolling motors. Menu options are dynamic and may vary depending on the motor setup.

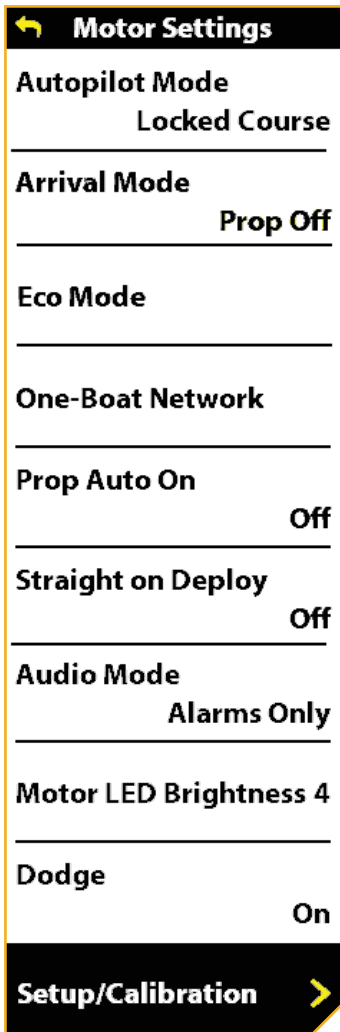

NOTICE: Select features are model specific. Eco Mode, Battery Notifications, Straight on Deploy, and Motor LED Brightness are only available on QUEST series trolling motors. Menu options are dynamic and may vary depending on the motor setup.

REMOTE NAVIGATION

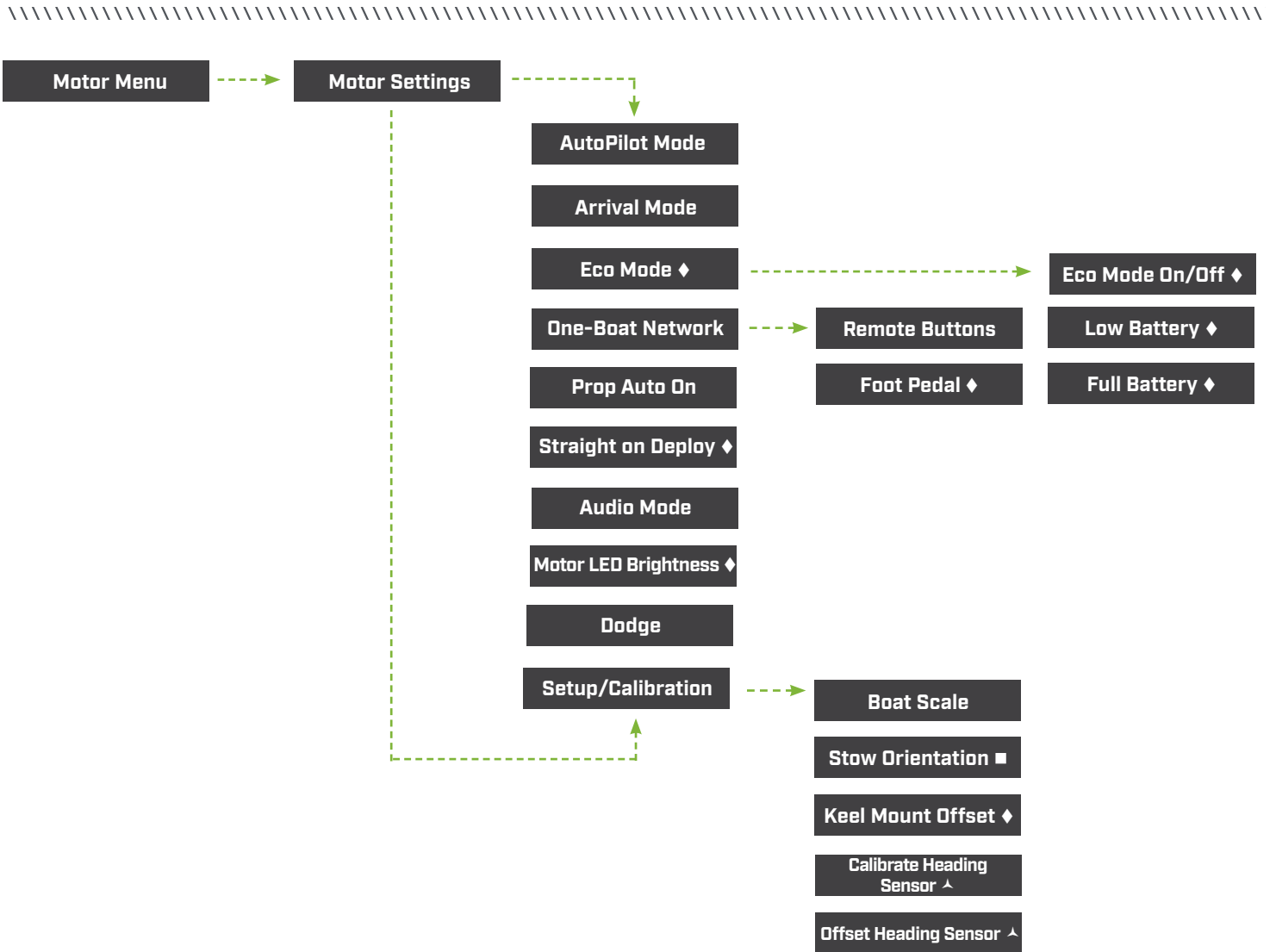

AUTOPILOT MODE - Sets the AutoPilot Mode to either Locked Heading or Locked Course.

ARRIVAL MODE - Sets the Arrival Mode on the Advanced GPS Navigation System when certain Navigation Modes are complete. The four arrival modes are Prop Off, Spot-Lock, AutoPilot, and Auto-Deploy Raptor/Talon.

ECO MODE - Turns Eco Mode to either "on" or "off." Turning on Eco Mode saves battery life by limiting thrust. Eco Mode is "off" by default. ◆

ECO MODE - Sets battery saving Eco Mode functions and notifications. Turning on Eco Mode saves battery life by limiting thrust. ◆

LOW BATTERY - Turns on the following Eco Mode notification when battery is below 20 percent: "Your battery is below 20%. Would you like to turn Eco Mode on?" The Low Battery notification is "on" by default. ◆

FULL BATTERY - Turns on the following Eco Mode notification when battery is above 80 percent: "Your battery is above 80%. Would you like to turn Eco Mode off?" The Full Battery notification is "off" by default. ◆

◆ Only available on QUEST series trolling motors. ■ Only available on select trolling motors. ▲ Only available on trolling motors with an external Heading Sensor.



ONE-BOAT NETWORK - Sets all of the possible functions for each of the four One-Boat Network buttons on the Wireless Remote and the One-Boat Network button on select foot pedals. See the One-Boat Network section of this manual for more information.

REMOTE BUTTONS - Lists the possible functions available for the OBN buttons on the Wireless Remote.

FOOT PEDAL - Lists the possible functions available for the OBN button on select foot pedals. ♦

PROP AUTO ON - Turns the Prop Auto On to either "on" or "off." When turned "on," the Prop will turn on when navigational features are used.

STRAIGHT ON DEPLOY - Turns Straight On Deploy to either "on" or "off." Turning Straight On Deploy "on" adjusts the position of the Lower Unit to the Keel Offset position. ♦

AUDIO MODE - Sets Audio Mode to either Alarms Only or All Sounds.

MOTOR LED BRIGHTNESS - Adjusts the brightness on the motor LED display. ♦

DODGE - Turns Dodge Mode to either "on" or "off."

SETUP AND CALIBRATION - Adjusts the Boat Scale, Stow Orientation and Keel Mount Offset. For trolling motors with an external Heading Sensor, it also calibrates and sets Heading Offset.

BOAT SCALE - Sets the proper amount of thrust for the size of the boat the trolling motor is installed on.

STOW ORIENTATION - Sets the Stow Orientation to either Prop Left or Prop Right. ■

KEEL MOUNT OFFSET - Adjusts the position of the motor in relation to the Keel. ♦

CALIBRATE HEADING SENSOR - Calibrates the Heading Sensor for maximum accuracy. ▲

OFFSET HEADING SENSOR - Sets the difference between the angle of the Keel of the boat and the angle at which the Heading Sensor is mounted to the deck of the boat. ▲

♦ Only available on QUEST series trolling motors. ■ Only available on select trolling motors. ▲ Only available on trolling motors with an external Heading Sensor.



REMOTE NAVIGATION

› My Data Menu

The My Data Menu is accessible by pressing the Menu  button. Use the My Data Menu to view saved navigation data, including Spot-Locks, Waypoints and iTracks.

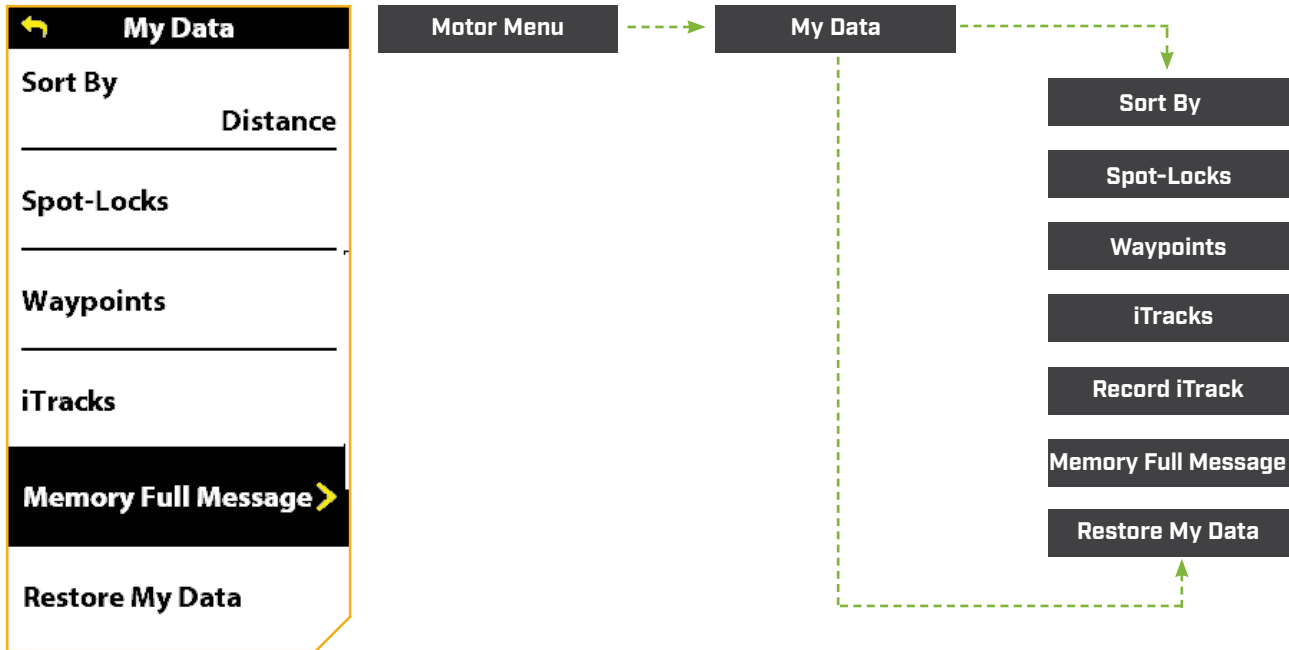

SORT BY - Sets the list sorting by distance, name or time.

SPOT-LOCKS - Lists all saved Spot-Locks.

WAYPOINTS - Lists all saved Waypoints.

ITRACKS - Lists all saved iTracks.

RECORD ITRACK - Initiates record an iTrack.

MEMORY FULL MESSAGE - Displays or hides the message that the memory on the trolling motor is full, and that data will be saved to a Humminbird unit when connected.

RESTORE MY DATA - Deletes all Spot-Locks, Waypoints and iTracks saved on the Wireless Remote.

» Preferences Menu

The Preferences Menu is accessible by pressing the Menu  button. Become familiar with the choices in the Preferences Menu to better customize the Wireless Remote. Options include selecting the background display theme, language displayed, units of measurement used, and the time zone.

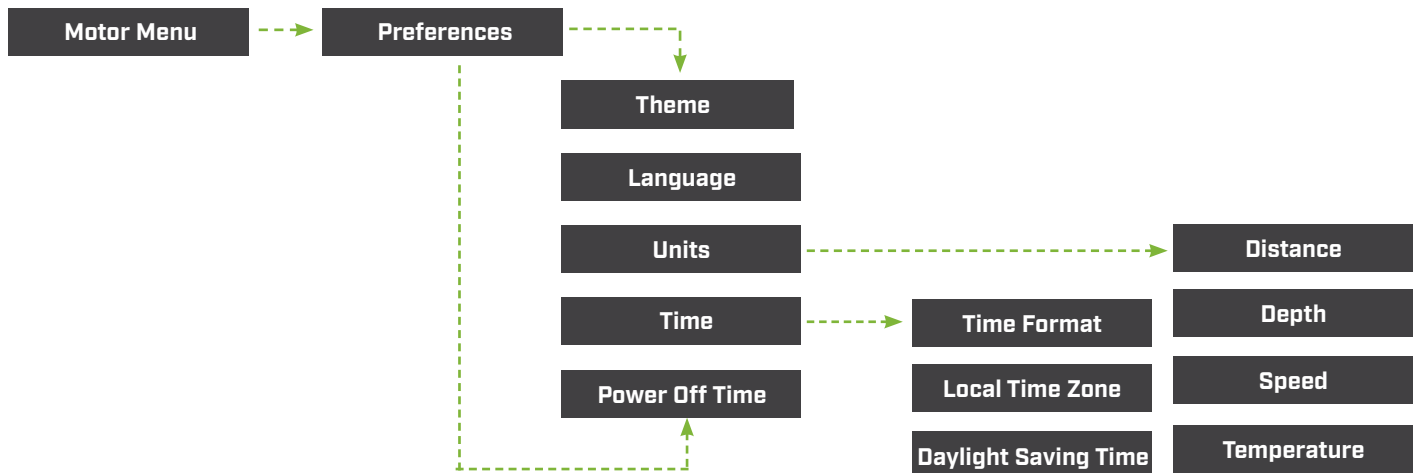
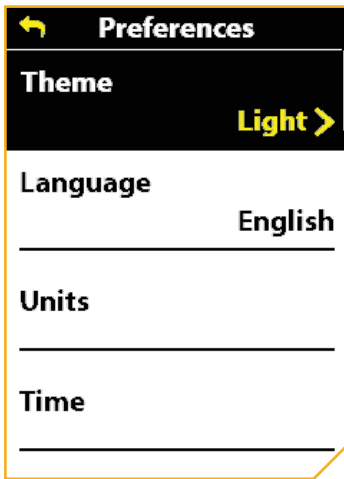

THEME - Sets the display Theme to either Light mode or Dark mode. Dark is the default.

LANGUAGE - Choose between one of twenty-two languages. The default language is English.

UNITS - Sets the unit of measurement for the Distance, Depth, Speed and Temperature.

DISTANCE - Sets the distance reading measurement in units of Feet or Meters. The default is set to Feet.

DEPTH - Sets the depth reading measurement in units of Feet or Meters. The default is set to Feet.

SPEED - Sets the speed measurements in units of mph (miles per hour) or kph (kilometers per hour). The default is set to mph.

TEMPERATURE - Sets the temperature readings to Fahrenheit or Celsius. The default is set to Fahrenheit.

REMOTE NAVIGATION



TIME - Sets the time format, local time zone and turns daylight saving time "on" and "off."

TIME FORMAT - Sets the time format to 12 hours or 24 hours. The default is set to 12 hours.

LOCAL TIME ZONE - Choose between thirty-five local time zones. The default is set to CST.

DAYLIGHT SAVING TIME - Turns Daylight Saving Time to either "on" or "off." The default is set to "off."

POWER OFF TIME - Sets the period of inactivity required to automatically power off the Wireless Remote to 30, 60, 90, or 120 minutes. The default is set to 120 minutes.

Bluetooth Menu

The Bluetooth Menu is accessible by pressing the Menu  button. Become familiar with the choices in the Bluetooth Menu to connect Bluetooth compatible products. Use this menu to pair any new devices or to review what devices you currently have connected to the network.

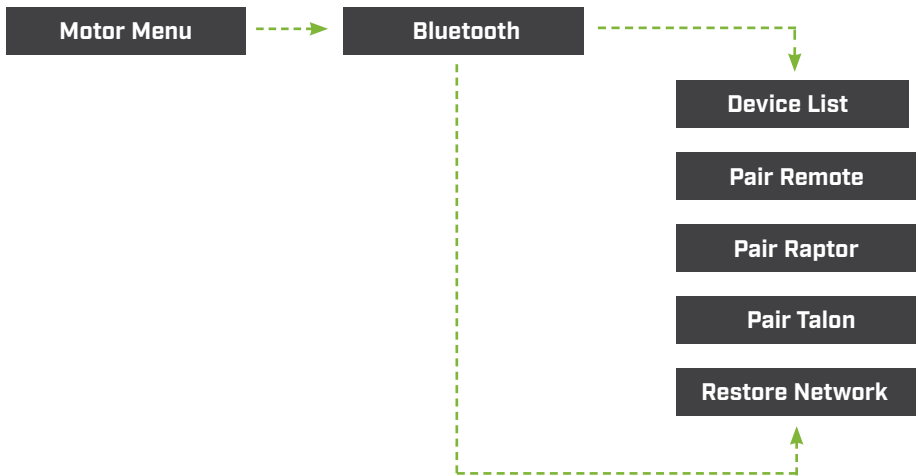
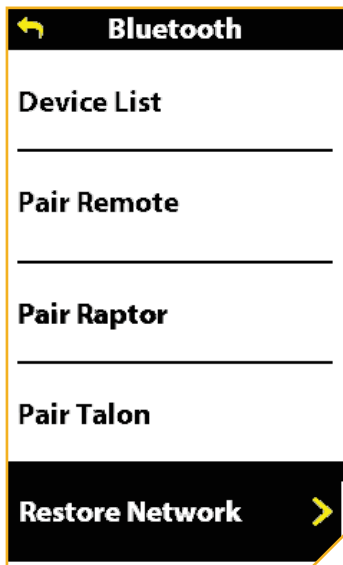

DEVICE LIST - Lists the current software version for the software package, motor, controller, and remote.

PAIR REMOTE - Used to pair the Wireless Remote to the trolling motor.



PAIR RAPTOR - Displays instructions to pair a Raptor to the trolling motor.

PAIR TALON - Displays instructions to pair a Talon to the trolling motor.

RESTORE NETWORK - Removes all paired devices from the remote.

› System Menu

The System Menu is accessible by pressing the Menu  button. System Menu selections include About, Diagnostic, Restore Defaults, and Update Software.

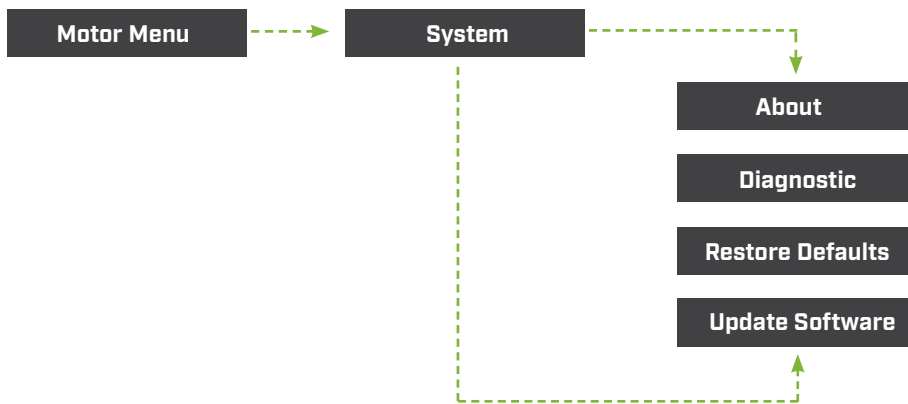
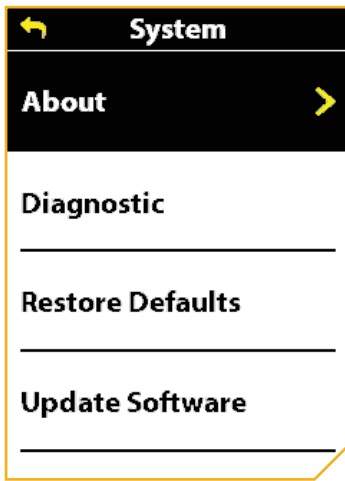

ABOUT - Lists the current software version for the software package, motor, controller, and remote.





DIAGNOSTIC - Lists the diagnostic readings available.

RESTORE DEFAULTS - Restores defaults to factory settings.

UPDATE SOFTWARE - Initiates software updates for the remote.

REMOTE NAVIGATION

POWER BUTTON

When using the Wireless Remote buttons, the Power  button will open the Power Menu system. The Speed Up  and Speed Down  buttons are used to move up and down the menu and the Steer Right  button is used to select a menu option.

Power Menu

The Power Menu is accessible by pressing the Power  button on the right side of the remote. Become familiar with the choices in the Power Menu to better control the Wireless Remote. Power Menu selections are dynamic, depending on your setup. Standard selections include Power Off, Backlight and Backlight Timeout. Additional selections may include Shallow Water Anchor and Motor menus when these devices are connected.

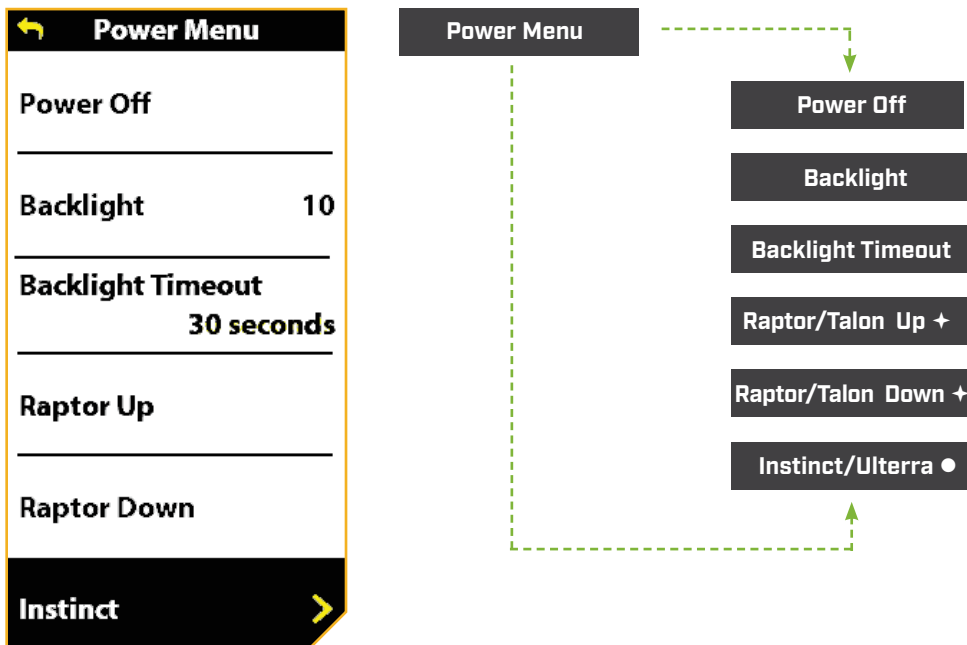

POWER OFF - Powers the remote "off."

BACKLIGHT - Sets the Backlight intensity to either "off" or a range of one to five. The default is "off."

BACKLIGHT TIMEOUT - Sets the timeout duration for the Backlight. It can be set to 10 seconds, 30 seconds, 1 minute, 5 minutes, and Always On. The default is 30 seconds.

RAPTOR/TALON UP - Only visible when a Raptor/Talon is paired. Use to retract the Raptor/Talon. †

RAPTOR/TALON DOWN - Only visible when a Raptor/Talon is paired. Use to deploy the Raptor/Talon. †

INSTINCT/ULTERRA - Only visible when an Ulterra, Ulterra QUEST & RT Instinct QUEST motor is connected. Use to stow and deploy the motor and adjust the trim. ●

† Only available with a paired Shallow Water Anchor.

● Only available with Ulterra, Ulterra QUEST & RT Instinct QUEST motors.

GETTING STARTED

THE ADVANCED GPS NAVIGATION SYSTEM

Advanced GPS Navigation is pre-installed on the trolling motor. The remote and GPS controller on the trolling motor make up the Advanced GPS Navigation system. The GPS controller is contained in the motor control head. It contains a very sensitive compass and is where all GPS satellite and remote signals are received. The remote comes paired to the GPS controller from the factory. The top of the motor control head also has a single Pair button to allow up to three remotes and the heading sensor to be paired to the system. A remote can only be paired with one controller at a time. If the system comes with an external heading sensor, the heading sensor needs to be installed and paired with the GPS controller. Please see the "Heading Sensor" portion of this manual for more information on the heading sensor. If the Advanced GPS Navigation system will be used with a Humminbird fish finder, the Ethernet connection between the trolling motor and the fish finder must be connected.

Before each startup, it is recommended to inspect the Wireless Remote, Prop, and Control Head for damage and to make sure that there are no obstructions that would affect communication between the Control Head, the GPS signal and the remote, or boat movement.

NOTICE: It is very important that the controller have a clear view of the sky in all directions and has a clear line of sight to the remote for optimum performance.

› Power

The Control Head will turn on whenever the trolling motor has power. Refer to the Owner's Manual for your specific motor to determine how to power up your trolling motor. Owner's Manuals can be found online at minnkota.johnsonoutdoors.com. It is recommended to turn off and disconnect the power source from the trolling motor when not in use.

› Accuracy

The accuracy and responsiveness with which the Advanced GPS Navigation system controls the boat is highly dependent upon many variables. Just a few of these variables and their general effects on responsiveness and accuracy are given below so that the behavior of the system can be understood.

⚠ CAUTION

This unit uses a magnetic compass to detect direction of travel. The compass can be adversely affected by magnets or large, ferrous metal objects near (within 24" of) the trolling motor control head.

Obstructions on the Prop may cause excessive vibration of the motor head. This vibration can cause the compass to wander and erratic steering to occur. Clear the obstruction to return the motor to normal operation.

Power should be disconnected from the motor when not in use. Removing the motor from the power source will ensure that current is not reaching the electronics when not in use.

Variable	Effect
Ratio of motor thrust to boat weight	Excessive thrust on a smaller boat can cause the Advanced GPS Navigation system to over correct. Not enough thrust on a large boat can cause the system to respond slowly.
Wind	Excessive wind and/or current can reduce the product's positioning accuracy.
GPS signal strength	The greater number of GPS signal bars the greater the accuracy.
Trolling motor battery power level	A fully charged battery will give the best performance.

› Navigation

The Advanced GPS Navigation system uses GPS satellite signals as well as digital compass data to know where it is, where its heading and the direction the motor is pointing. Since the system depends on GPS satellite signals for navigation, a minimum GPS signal of one bar is required in order for GPS navigation controls to be enabled. Best results are achieved when GPS signals of four bars can be obtained.

› Range

The range of the remote will be greatly reduced if it is used near or mounted to any metal object, including aluminum or steel. It is also recommended that the top of the remote, by the display screen, not be obstructed during use.

GETTING STARTED



› Battery

The remote is powered by two AA batteries. To adjust the length of time that the remote stays powered on, please review the "Change Power Off Time" in the Remote Controls section of this manual, or in Preferences on the Wireless Remote.

NOTICE: Remote battery life is subject to frequency of use and is especially impacted by how bright and often the LCD backlight is used.

CAUTION

Extreme temperatures can lead to battery damage, such as capacity loss, leakage or rupture of battery. A damaged battery may damage your remote. Avoid storing your remote in extreme temperatures. The operating temperature of the remote is -10C to 50C (14 °F to 122 °F).

› Humminbird Control

Certain Advanced GPS Navigation System features can only be initiated from a compatible Humminbird fish finder. When the Wireless Remote is connected to a Humminbird, features such as Follow the Contour, Follow the Shoreline, Circle Mode and Routes can only be initiated from the Humminbird. Follow the Contour and Follow the Shoreline also require a compatible LakeMaster or CoastMaster chart card or AutoChart Live maps. Active Bands for these functions can be viewed on the Wireless Remote, and minimal control can only be exercised over these functions from the remote. For a full list of features and information on how to control the Wireless Remote with the Humminbird, please see the Humminbird documentation. For a list of Humminbird units and SD cards that are compatible with Advanced GPS Navigation Systems, please visit minnkota.johnsonoutdoors.com.



SYSTEM STARTUP >

> Connect the Advanced GPS Navigation System to the Humminbird

The Ethernet cable from the trolling motor for the Advanced GPS Navigation system can be connected directly to the Humminbird or to the Humminbird Ethernet Switch (optional). If you purchase the Ethernet Switch, install it using the instructions included in the Ethernet Installation Guide. The Ethernet Extension Cable is optional for your installation. Ethernet switches, Ethernet cables, and extension cables can be purchased online at humminbird.johnsonoutdoors.com. Depending on the shape of the Ethernet port on your Humminbird fish finder, an additional Ethernet adapter cable may be required for the installation. Refer to your fish finder operations manual or see the Advanced GPS Navigation System Compatibility Chart online at minnkota.johnsonoutdoors.com.

- 1**
 - a. Follow the instructions in the trolling motor Owner's Manual to connect and route the Eight-Pin Advanced GPS Ethernet Connector to the Ethernet Cable. The exact location and routing instructions will vary depending on the motor model.
 - b. **To install the Ethernet Cable**, align the pins on the Advanced GPS Ethernet Connector with the Receptacle on the Ethernet Cable. Notice the keyed connectors. Press the ends together and tighten the Collar from the Ethernet Cable to secure the connection.
 - c. The Ethernet Cable will plug directly into a SOLIX or APEX Fish Finder or directly into a HELIX Adapter Cable.

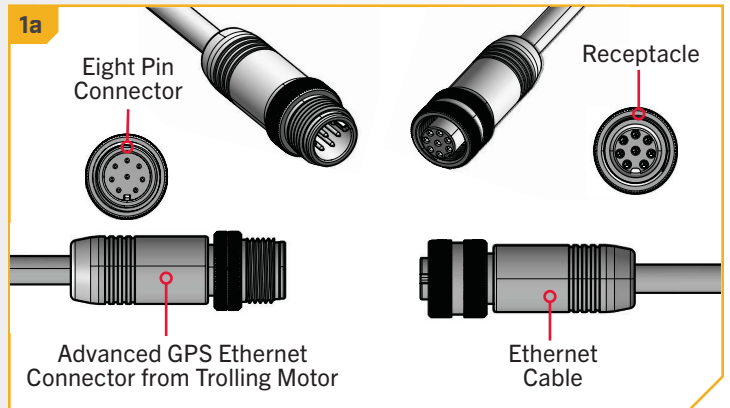

NOTICE: The Ethernet Cable has a Receptacle for the Advanced GPS Ethernet Connector on both ends and either end may be connected.

- 2**
 - d. **If installing directly to a SOLIX or APEX**, the connector will be flat on the back of the fish finder display.
 - e. Align the Receptacle on the Ethernet Cable with the Eight Pin Connector on the APEX or SOLIX fish finder. Notice the keyed connectors. Tighten the Collar from the Ethernet Cable to secure the connection. Once directly installed to the SOLIX or APEX, the connection is complete.

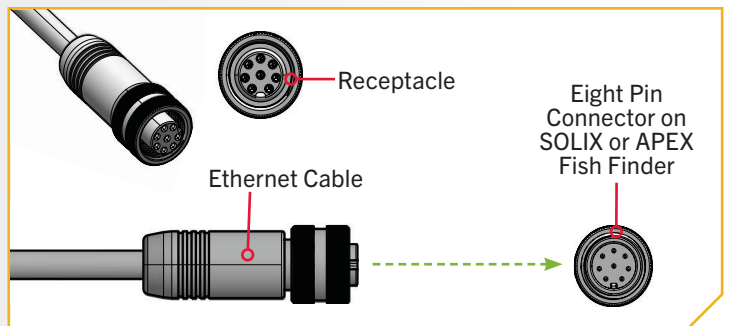

GETTING STARTED

3

- f. If installing directly to a HELIX Adapter Cable, align the Receptacle on the Ethernet Cable with the Eight Pin Connector on the HELIX Adapter Cable provided. Notice the keyed connectors. Tighten the Collar from the Ethernet Cable to secure the connection.

NOTICE: Minn Kota provides one HELIX Adapter Cable (AS EC QDE - Ethernet Adapter Cable - 720074-1) with every trolling motor equipped with Advanced GPS Navigation.

- g. The HELIX Adapter Cable directly connects the Ethernet Cable to a HELIX fish finder. Locate the HELIX Adapter Cable Keyed Connector on the back of the fish finder. Plug the HELIX Adapter Cable into the back of the HELIX fish finder to complete the connection.

NOTICE: Once the Ethernet connection is complete, and before operating the trolling motor, secure the connection cables. Follow the instructions "Securing the Connection Cables" section of the trolling motor owner's manual.

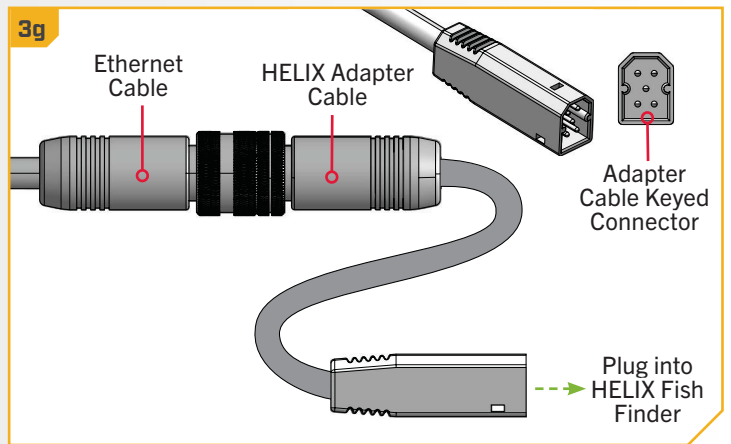
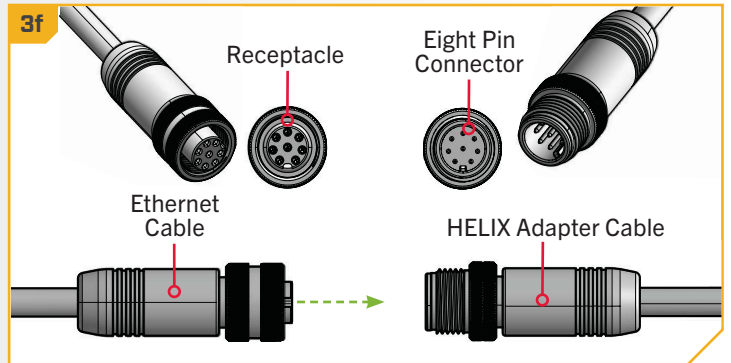

Powering up the Advanced GPS Navigation System

Follow these simple steps each time you power up your trolling motor for successful operation:

1

- a. Connect trolling motor to power.





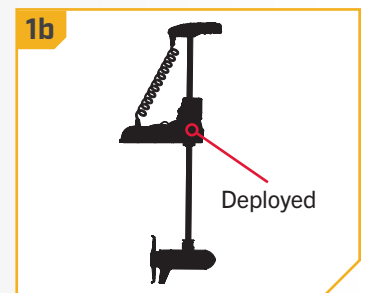
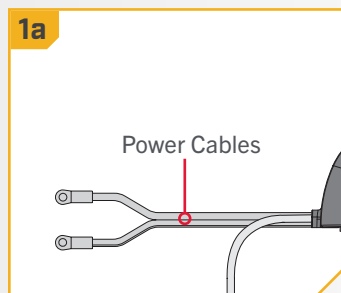

NOTICE: For instructions on how to connect the trolling motor to power, please see the "Battery & Wiring Installation" section of the trolling motor Owner's Manual.

- b. Deploy trolling motor into water.

NOTICE: Advanced GPS Navigation startup varies slightly between trolling motor models. The controller in the Control Head can communicate with the remote when the motor is stowed as long as the motor and remote have power. When the motor is stowed, remote buttons will be disabled.



2

- c. Press and hold the Power  button on the Wireless Remote. The display screen will turn on. A message about the Advanced GPS Navigation system operation will appear on the display screen. Read the disclaimer before continuing.
- d. An "I Agree" button will be present at the bottom of the Content Area. After reading the disclaimer, select the "I Agree" button" by pressing the Steer Right  button.
- e. The content on the Dashboard will populate.
- f. All manual functions in the remote, including Speed Up , Speed Down , Steer Left , Steer Right , and Prop On/Off  are active.
- g. After the Advanced GPS Navigation system has obtained a minimum GPS signal strength of one bar, all remaining functions will become available.

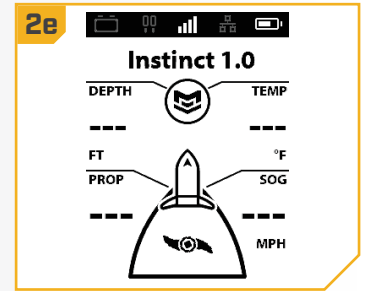
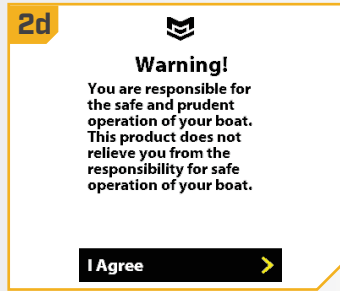



NOTICE: The appearance of the Dashboard will vary slightly based on motor model.

› Powering Off the Wireless Remote

Power off the Wireless Remote when not in use to conserve battery life.

1

- a. Press the Power  button on the remote.
- b. Power Off will be highlighted in the Power Menu. Press the Steer Right  button to select it.
- c. It will cycle through the three second countdown and power off.

OR

- c. Press and hold the Power  button on the remote. Hold the button for three seconds or until the countdown completes.

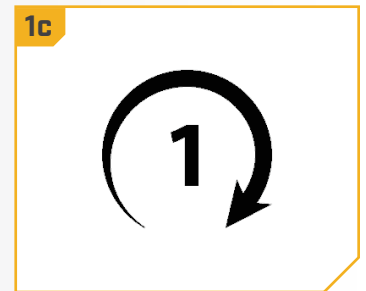
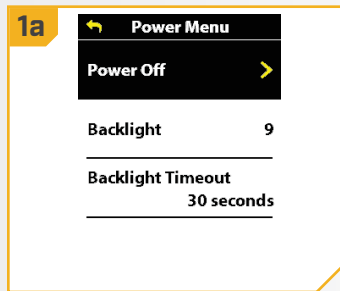

GETTING STARTED

Changing the Remote Battery

The remote is powered by two AA batteries. Follow these simple steps each time you need to change the batteries.

1

- a. Locate the screw on the back of the remote.
- b. Use a #2 Phillips screwdriver to loosen the screw.
- c. Slide the Back Cover of the remote away to remove it.

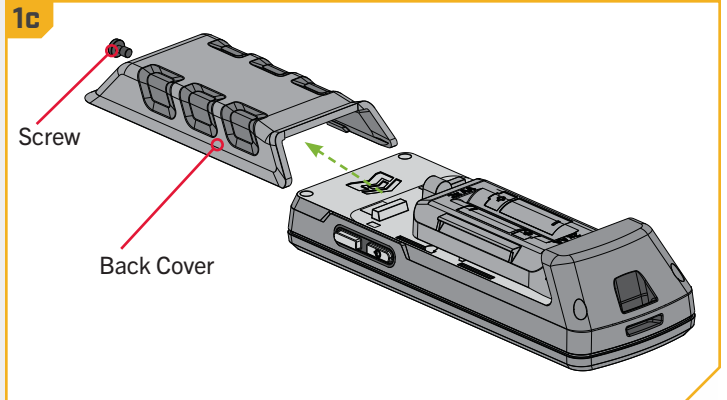

2

- d. Firmly grip the left and right tabs on the Battery Cover and pull up to remove it.
- e. Remove the existing AA batteries by the positive (+) end.
- f. Insert two AA batteries, using the positive (+) and negative (-) guides on the battery label and on the Battery Cover to insert the batteries in the proper direction. Be sure to insert the negative (-) end first. Replace the Battery Cover, making sure to press it all the way down. The Battery Cover needs to be fully seated to re-install the Back Cover.
- g. Slide the Back Cover in place on the remote and tighten the screw using a #2 Phillips screwdriver.

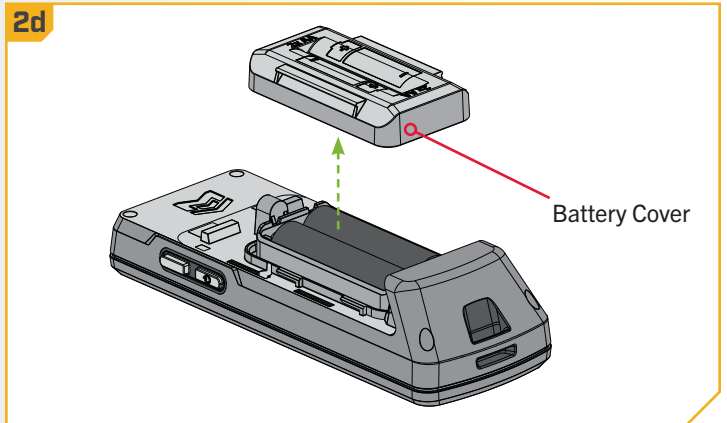

UNDERSTANDING AUDIO MODES

The controller in the Control Head contains an internal speaker which can be configured from the remote to play all sounds or only play alarm sounds. Review the modes below to determine what audio patterns are caused by conditions in each audio mode.





Audio Pattern	What Condition Causes the Audio Pattern	All Sounds	Alarms Only
Single Beep	Audio Mode changed to Alarms Only	X	X
	Manual Prop on	X	
	Speed + (When less than maximum speed)	X	
	Speed - (When greater than speed 0)	X	
	Start iTrack, Circle Mode, Follow the Contour, Drift Mode and Route Navigation	X	
	Enabling or disabling Record, Go To, AutoPilot, Cruise Control or Spot-Lock	X	
	Enable Max Speed	X	
	Spot-Lock Jog any direction	X	
	Adjust Cruise Control Target Speed +/-	X	
Double Beep	Audio Mode changed to All Sounds	X	X
	Manual Prop off	X	
	Disable Max Speed	X	
Three Long Beeps	Pair successfully completed	X	X
Four Short Beeps	Startup	X	X
Error Tone (A series of short quick beeps for .6 seconds)	Saving Spot-Lock, Waypoint or iTrack failed	X	X
	Spot-Lock, Waypoint or iTrack storage full	X	X
	Unable to run Route	X	X
	Attempting to enable any GPS feature with no GPS signal	X	X
	Loss of GPS signal during navigation or Cruise Control	X	X
	When overriding navigation or Spot-Lock by steering with foot pedal or remote	X	X
	Trying to deploy Talon/Raptor when not in ready state	X	X
	Trying to deploy Talon/Raptor when Speed Over Ground is too high	X	X
	Attempting to replay iTrack or recall Spot-Lock or Waypoint when boat is beyond the minimum required distance	X	X
	Change foot pedal speed dial during Cruise Control or Drift Mode	X	X
	Stowing with Prop on	X	X
Trimming too high with Prop on	X	X	
High-Low, High-Low, High-Low	Arrival at Waypoint	X	
	End iTrack or Route attained during track playback (in conjunction with canceling mode and turning the Prop off)	X	
Repeating Tone	Ulterra/Instinct stow error	X	X
Steady Tone	Pair button is pressed	X	X

GETTING STARTED

AUDIO MODE CONTROL >

> Changing the Controller Audio Mode

1

- a. Press the Menu  button.
- b. Scroll through the Content Area using the Speed Down  or Speed Up  button to find Motor Settings.
- c. Select Motor Settings by pressing the Steer Right  button.
- d. Scroll to Audio Mode and select it by pressing the Steer Right  button.

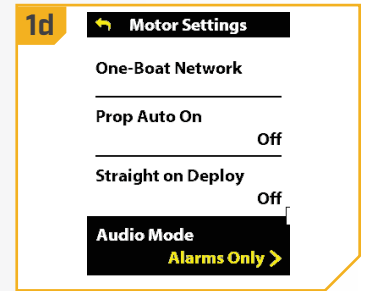
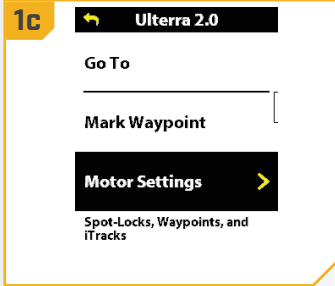

2

- e. Once in the Audio Mode menu, select either "Alarms Only" or "All Sounds." The circle to the right of the selected mode will be colored in yellow when selected.
- f. To exit the menu, press and hold the Menu  button to return to the Dashboard.

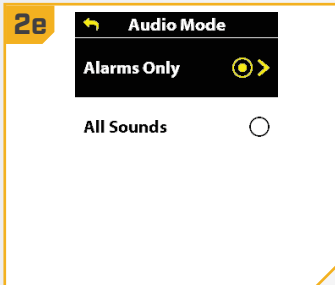

HEADING SENSOR

HEADING SENSOR FEATURES

The Minn Kota Heading Sensor provides boat heading information to Bluetooth compatible Minn Kota trolling motors with Advanced GPS Navigation. It contains a compass that senses the boat's heading. The boat heading is used by the system for navigation features such as Spot-Lock Jog. The Heading Sensor does not contain a GPS receiver and it does not change or control the orientation of the boat.

WARNING

The Heading Sensor should not be used as a navigational aide to prevent collision, grounding, boat damage, or personal injury. When the boat is moving, water depth may change too quickly to allow time for you to react. Always operate the boat at very slow speeds if you suspect shallow water or submerged objects.

Trolling motors installed with the Advanced GPS Navigation system may contain either an internal or external Heading Sensor. The Heading Sensor enables specific functions that enhance motor navigation. Refer to the chart below to determine the features enabled for each Heading Sensor type. In order to get the best performance out of the Heading Sensor, Minn Kota recommends completing the Keel Offset or Heading Offset. For trolling motors with an external Heading Sensor, it is important to calibrate the Heading Sensor and set the Heading Offset. For trolling motors with an external Heading Sensor, please follow the instructions for installation and operation included in the Heading Sensor Owner's Manual. For trolling motors with a built-in Heading Sensor, complete the Keel Offset directions in this manual.

Trolling Motor Model	Heading Sensor		Setup Type			Features		
	External	Built-in	Calibration	Heading Offset	Keel Offset	Spot-Lock Jog	Straight on Deploy	Stow Orientation
PowerDrive & RT PowerDrive	X		X	X		X		
Terrova & RT Terrova	X		X	X		X		
Terrova QUEST & RT Terrova QUEST		X			X	X	X	X
Ulterra	X		X	X		X		X
Ulterra QUEST & RT Instinct QUEST		X			X	X	X	X
Ultrex	X		X	X		X		
Ultrex QUEST		X	X		X	X	X	X

NOTICE: PowerDrive and RT PowerDrive trolling motors do not come from the factory with a Heading Sensor. An external Heading Sensor may be added as an accessory to all PowerDrive and RT PowerDrive motors. Find the Heading Sensor Assembly (1866680) online at minnkota.johnsonoutdoors.com.

HEADING SENSOR







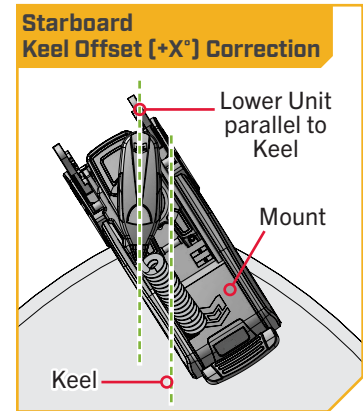
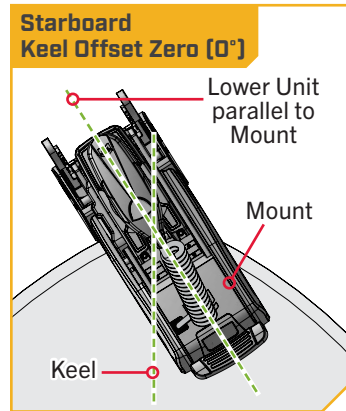
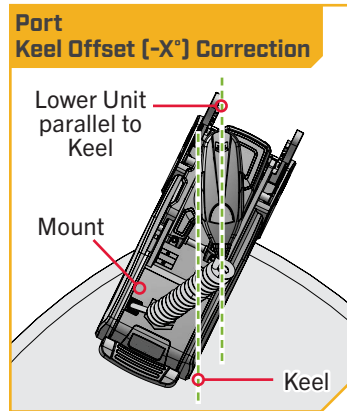
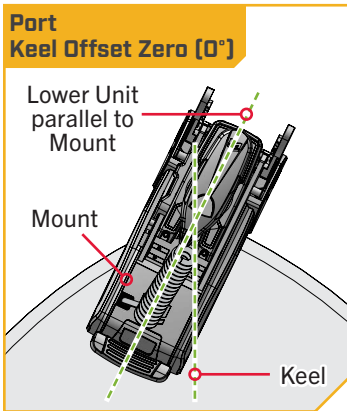



› Keel Offset with Keel Mount Offset

Minn Kota trolling motors with a built-in Heading Sensor come from the factory with the Lower Unit parallel to the Mount. The position of the Lower Unit is referred to as the Keel Offset. When the Lower Unit is parallel to the Mount, the Keel Offset is zero degrees. In an ideal installation, the Lower Unit will be parallel to the Keel, however, the Mount is rarely installed to be perfectly in-line with the Keel, therefore the Lower Unit will not be parallel with the Keel. Nearly all installations will have some variation in mounting position to either the Port or Starboard side of the boat. The Keel Offset is specified with the Keel Mount Offset function. When setting the Keel Offset, any position towards the Port will record a Keel Offset with a negative angle. Any position towards Starboard will record a Keel Offset with a positive angle.

NOTICE: For Ultrex QUEST trolling motors, complete all installation steps before adjusting the Keel Offset. This includes mounting the trolling motor to the deck of the boat, calibrating or rotating the Pedal Control Sleeve Assembly, and installing and securing the power and accessory cables. For more information, follow all of the installation instructions provided in the Ultrex QUEST Owner's Manual found online at minnkota.johnsonoutdoors.com.







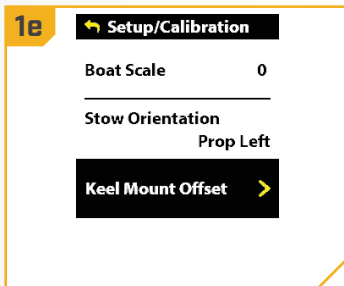
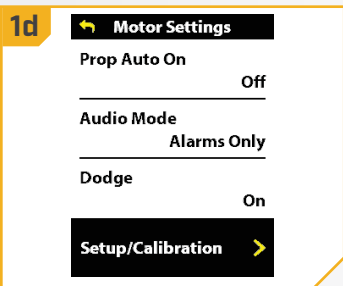
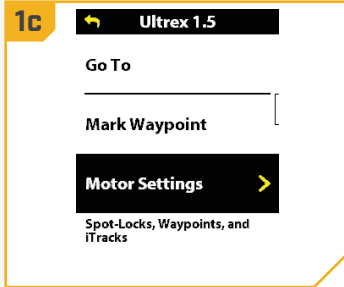
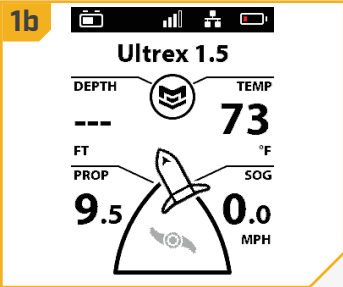

1

- a. Turn on the Wireless Remote for the Advanced GPS Navigation system. Make sure the Wireless Remote is paired to the trolling motor.
- b. On the Wireless Remote, press the Menu  button.
- c. Use the Speed Down  or Speed Up  button to find the Motor Settings menu. Use the Steer Right  button to select Motor Settings.
- d. In the Motor Settings menu, use the Speed Down  or Speed Up  button to find Setup/Calibration. Use the Steer Right  button to select Setup/Calibration.
- e. In the Setup/Calibration menu, use the Speed Down  or Speed Up  button to find Keel Mount Offset. Use the Steer Right  button to select Keel Mount Offset.



2

- f. Review all safety warnings. Follow the prompts on the Wireless Remote. Use the Steer Right  button to select Start and begin the process.
- g. Use the Steer Right  or Steer Left  button to point the motor forward and parallel to the Keel.
- h. When satisfied with the placement of the trolling motor, use the Speed Down  or Speed Up  button to scroll to Set. Use the Steer Right  button to select Set. The degree of offset is displayed at the bottom of the Dashboard.
- i. Press and hold the Menu  button to close out Keel Offset and return to the home screen.

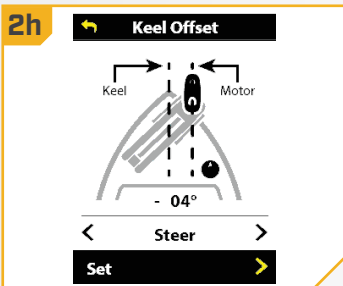
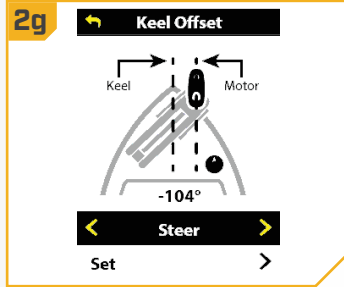
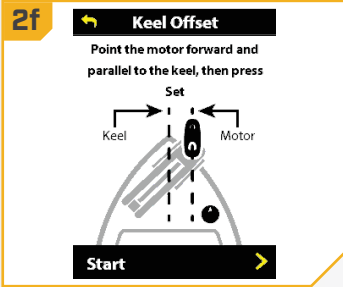

ONE-BOAT NETWORK

ONE-BOAT NETWORK OVERVIEW

As one company, Humminbird and Minn Kota constantly look for ways that our products can seamlessly integrate and communicate – unlocking more features, capabilities and putting you in command of a fully connected fishing system. That’s why we created the One-Boat Network: a commitment to making the most advanced fishing gear even better, by allowing it to work together.

Download the One-Boat Network App to get the most out of your time on the water. With the One-Boat Network App you can control your trolling motor and shallow water anchors, transfer charts to your APEX, SOLIX, or HELIX series fish finder, update system software from your mobile device to your Humminbird and Minn Kota products, and receive real-time technical support with our Request A Call Back feature. You can also purchase, download, and display Humminbird CoastMaster and LakeMaster charts and create, save, and navigate waypoints, routes, and tracks.

The One-Boat Network allows for communication of the following Humminbird, Minn Kota and Cannon products:

- Minn Kota trolling motor with Advanced GPS Navigation Systems and Built-in Mega Imaging
- Humminbird APEX, SOLIX and Select HELIX Multi-functional displays
- Minn Kota Shallow Water Anchors
- All Minn Kota and Humminbird related remotes and wireless foot switches
- The One-Boat Network App
- Cannon Optimum Downriggers

With the full power of the One-Boat Network, you can:

CAST MORE, STEER LESS - Select a depth contour (or the shoreline) and activate the “Follow” function to automatically navigate your boat along a depth contour.

TAKE COMMAND WITHOUT LIFTING A FINGER - Take total control of your trolling motor to easily steer, engage Spot-Lock, and even stow or deploy on select motors directly from a Wireless Remote, the One-Boat Network app or a Humminbird fish finder.

ANCHOR FROM ANYWHERE - Deploy, retract or adjust anchor settings of a Talon or Raptor Shallow water anchor directly from a Wireless Remote, the One-Boat Network app or a Humminbird fish finder.

PRECISION DEPTH CONTROL - Wirelessly network up to four Cannon Optimum downriggers and control them all or individually from one screen.

ON-THE-GO ACCESS - Take control with you. The One-Boat Network app lets you transfer software updates wirelessly, view and manage your network and connect with technical support.

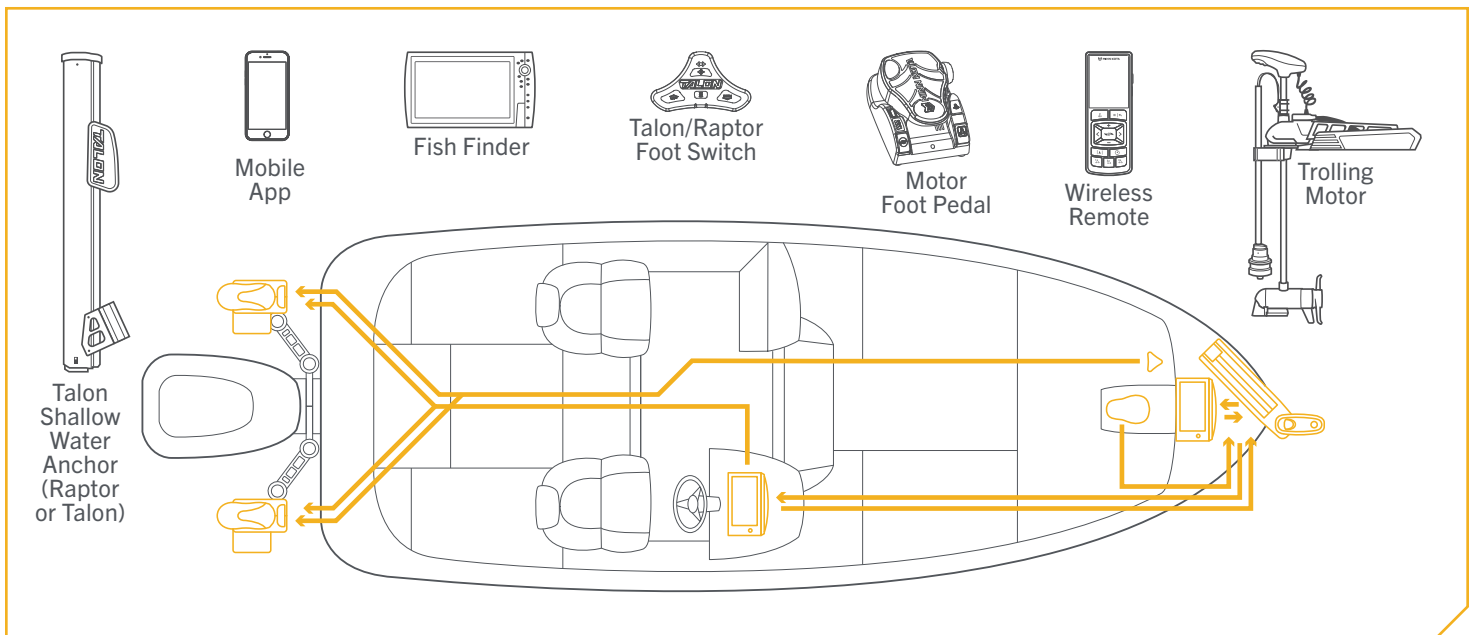

NOTICE: Select Minn Kota trolling motors have additional product configuration completed through the Wireless Remote or the One-Boat Network App. Setup may include physical or electronic installation of the Heading Sensor to enable certain navigation functions. Please review the “Heading Sensor” section of this Owner’s Manual. Once the Heading Sensor installation is complete, finalize the trolling motor configuration using the Wireless Remote or the One-Boat Network app.

To set up the trolling motor using the Wireless Remote, refer to this manual’s “One-Boat Network Adjustments” section. To set up the trolling motor using the One-Boat Network app, see the “One-Boat Network Adjustments” section of the trolling motor Owner’s Manual online at minnkota.johnsonoutdoors.com. Also, find the app setup in the One-Boat Network Owner’s Manual at humminbird.johnsonoutdoors.com. The Wireless Remote helps the user configure One-Boat Network controls to enhance the operation of the One-Boat Network product. These controls include:

1. Customizing the One-Boat Network buttons on the Wireless Remote
2. Customizing the function of the One-Boat Network button on select trolling motor Foot Pedals

CUSTOMIZING THE ONE-BOAT NETWORK BUTTONS ON THE WIRELESS REMOTE >

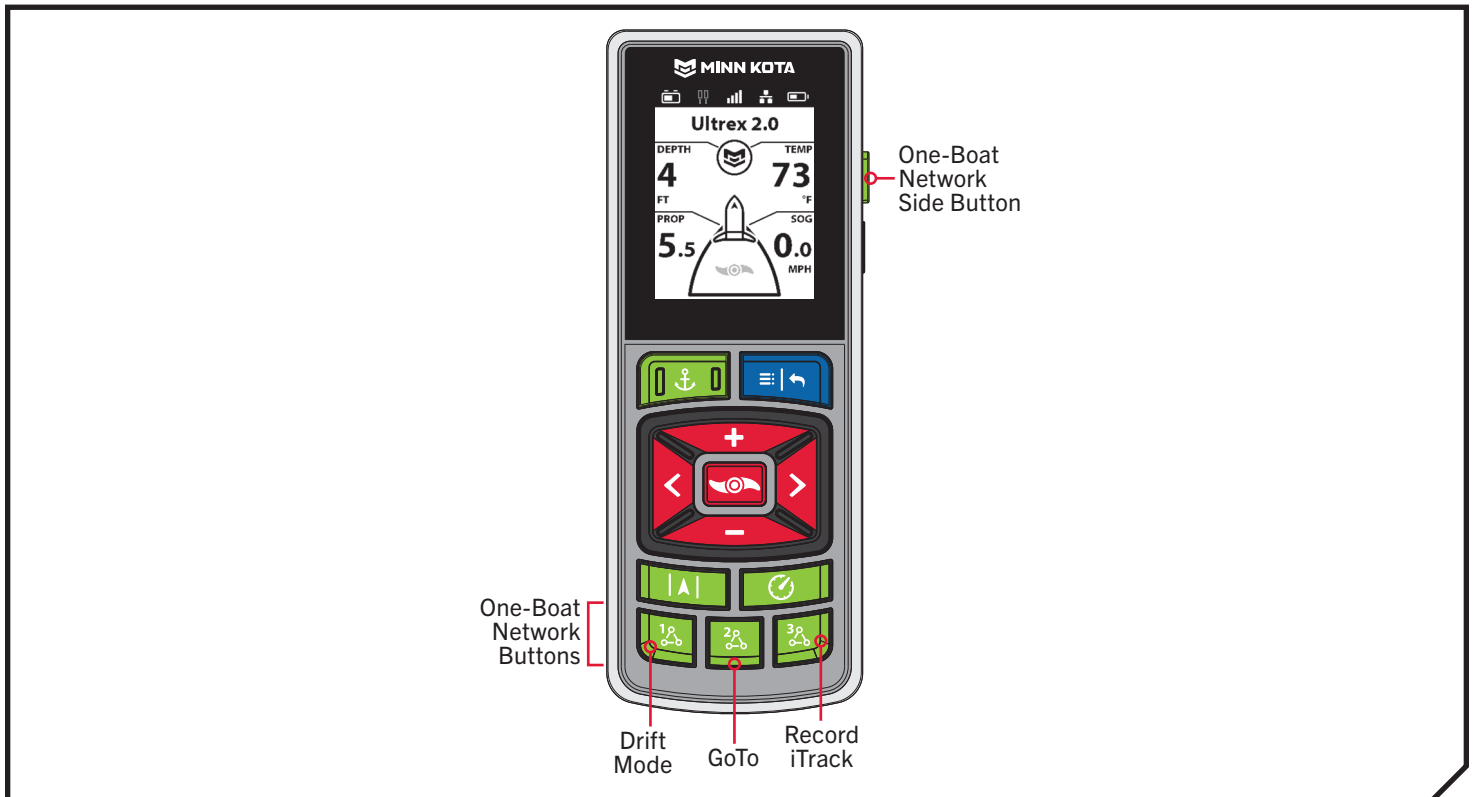

One-Boat Network Default Buttons

	Drift Mode		Record iTrack
	GoTo		Mark a Waypoint/Deployment Mode

ONE-BOAT NETWORK



Function	Icon	Description
Drift Mode		Drift mode is the default function for OBN Button 1. Press once to engage Drift Mode. Press a second time to Adjust Course.
Go To		Go To is the default for the OBN Button 2. Press once to open the Go To Menu. The Go To options are Spot-Locks, Waypoints, iTracks and Drift.
Record iTrack		Record iTrack is the default function for OBN Button 3. Press once to start recording an iTrack. Press a second time to save the iTrack.
Waypoint		Mark Waypoint if the default function for the OBN Side Button on motors that do not have Deployment Mode. Press once to save a Waypoint.
Max Speed		Max Speed must first be customized to one of the OBN buttons. Double press to engage Max Speed. Single press to return to the previous speed.
Talon/Raptor		The shallow water anchor function must first be customized on one of the OBN buttons. The shallow water anchor function will display as Talon or Raptor depending on your configuration. Double press to deploy the anchor. Press once to pause or stow the anchor.
Deployment Mode		Deployment Mode is the default function for the OBN Side Button on the Wireless Remote for trolling motors with a stow/deploy and trim function. The Deployment Mode function will display as Ulterra QUEST & Riptide Instinct QUEST, depending on your configuration. Press the OBN Side Button once to bring up the Ulterra QUEST & Riptide Instinct QUEST menu.

› Customize the One-Boat Network Buttons on the Wireless Remote

1

- On the Wireless Remote, press the Menu button to open the Motor Menu.
- In the Motor Menu, use the Speed Down or Speed Up button to find the Motor Settings menu. Use the Steer Right button to select Motor Settings.
- In the Motor Settings menu, use the Speed Down or Speed Up button to find One-Boat Network. Use the Steer Right button to select One-Boat Network.
- In the One-Boat Network Menu, use the Speed Down or Speed Up button to find Remote Buttons. Use the Steer Right button to select Remote Buttons.

1a



Wireless Remote

Menu Button

1b

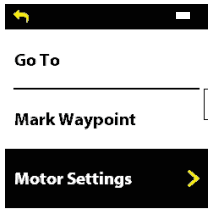

Go To

Mark Waypoint

Motor Settings >

Spot-Locks, Waypoints, and iTracks

1c

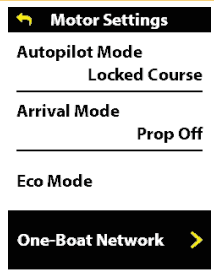

Motor Settings

Autopilot Mode
Locked Course

Arrival Mode
Prop Off

Eco Mode

One-Boat Network >

1d

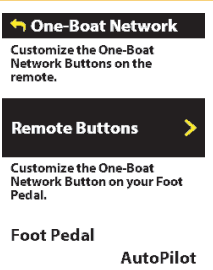

One-Boat Network

Customize the One-Boat Network Buttons on the remote.







Remote Buttons >

Customize the One-Boat Network Button on your Foot Pedal.

Foot Pedal
AutoPilot

38 | minnkota.johnsonoutdoors.com ©2023 Johnson Outdoors Marine Electronics, Inc.

2

- e. Use the Speed Down  or Speed Up  button to highlight the OBN button to customize. There are four options: Button 1, Button 2, Button 3 or Side Button. Press the Steer Right  button to make the selection.
- f. Use the Speed Down  or Speed Up  button to scroll through the options. Use the Steer Right  button to select the function.

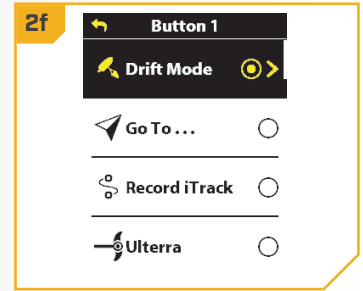
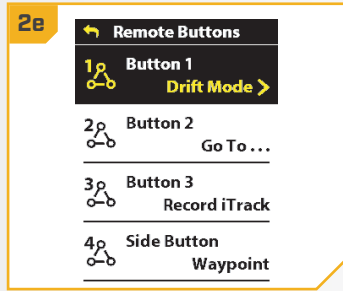

NOTICE: The radio button next to the desired function will be selected when the Steer Right  button is used to customize the function. The function options listed are based on the trolling motor and other devices in the Advanced GPS Navigation network.

NOTICE: For quick customization, press and hold the OBN button you want to customize to quickly bring up the customization screen.

- g. Press and hold the Menu  button to close and return to the Home Screen.



ONE-BOAT NETWORK

CUSTOMIZING THE ONE-BOAT NETWORK BUTTON ON THE FOOT PEDAL

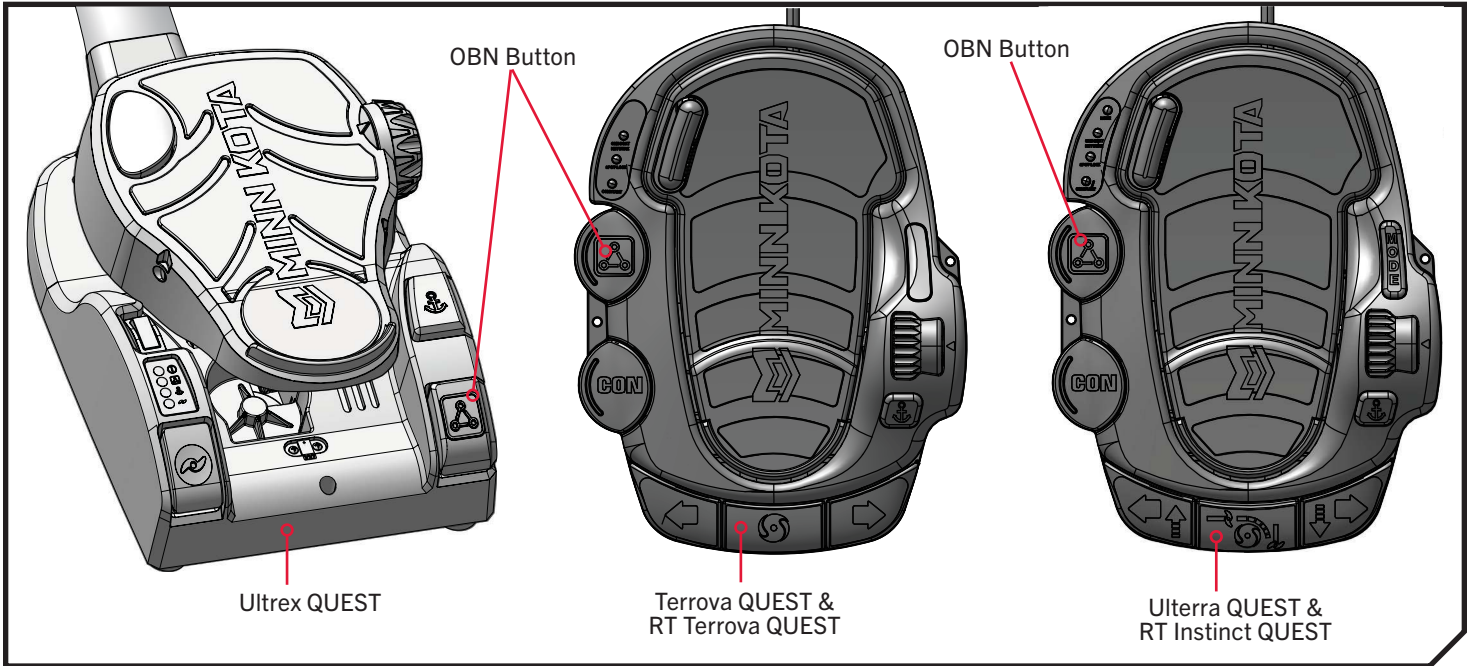
Select Minn Kota trolling motors have a programmable One-Boat Network button on the foot pedal.









The One-Boat Network  button on the Foot Pedal can be customized to control the following functions:

Function	Icon	Operation	LED Indication
AutoPilot (default)		Engage and disengage AutoPilot	Red LED will illuminate when AutoPilot is engaged and stay on until disengaged.
Waypoint		Mark a Waypoint	Red LED will illuminate when the One-Boat Network button is pressed and then turn off, signaling that a Waypoint was marked.
Shallow Water Anchor (Raptor/Talon)		Deploy and retract a Raptor/Talon	Red LED will steadily flash when the Shallow Water Anchor is deploying or stowing. Red LED will stay illuminated when the anchor is at any state of deployment, including when it is paused. Red LED will turn off when the anchor is fully stowed.





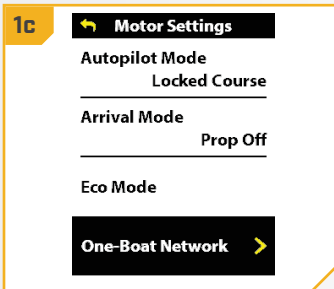
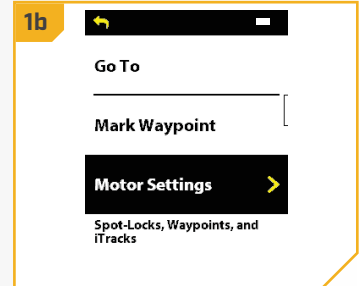

» Customize the One-Boat Network Button on the Foot Pedal with the Wireless Remote

1

- a. On the Wireless Remote, press the Menu  button to open the Motor Menu.
- b. In the Motor Menu, use the Speed Down  or Speed Up  button to find the Motor Settings menu. Use the Steer Right  button to select Motor Settings.
- c. In the Motor Settings menu, use the Speed Down  or Speed Up  button to find One-Boat Network. Use the Steer Right  button to select One-Boat Network.



2

- d. In the One-Boat Network menu, use the Speed Down  or Speed Up  button to find Foot Pedal. Use the Steer Right  button to select Foot Pedal.
- e. In the Foot Pedal menu, use the Speed Down  or Speed Up  button to find the desired function. Use the Steer Right  button to select the function.
- f. Press and hold the Menu  button to close and return to the Home Screen.

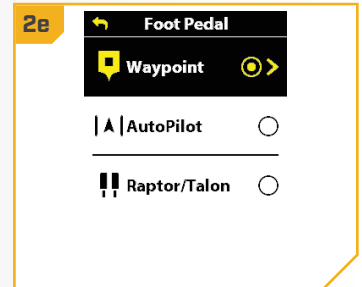

NOTICE: The radio button next to the desired function will be selected when the Steer Right  button is used to customize the function. AutoPilot is the default selection for Ulterra QUEST and Riptide Instinct QUEST series trolling motors. The function options listed are based on the trolling motor and other devices in the Advanced GPS Navigation network.

■ Only available on select trolling motors.

ONE-BOAT NETWORK

ONE-BOAT NETWORK ADJUSTMENTS

Keel Offset with Keel Mount Offset

Minn Kota QUEST series trolling motors with a built-in Heading Sensor come from the factory with the Lower Unit parallel to the Mount. The position of the Lower Unit is referred to as the Keel Offset. When the Lower Unit is parallel to the Mount, the Keel Offset is zero degrees. In an ideal installation, the Lower Unit will be parallel to the Keel, however, the Mount is rarely installed to be perfectly in-line with the Keel, therefore the Lower Unit will not be parallel with the Keel. Nearly all installations will have some variation in mounting position to either the Port or Starboard side of the boat. The Keel Offset is specified with the Keel Mount Offset function. When setting the Keel Offset, any position towards the Port will record a Keel Offset with a negative angle. Any position towards Starboard will record a Keel Offset with a positive angle. Before adjusting the Keel Offset, complete all installation steps. This includes mounting the trolling motor to the boat and installing power and accessory cables.



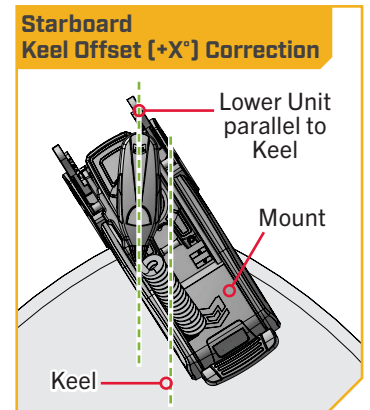
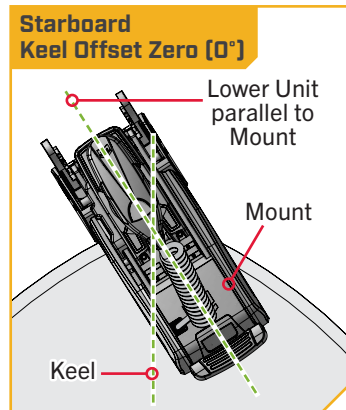
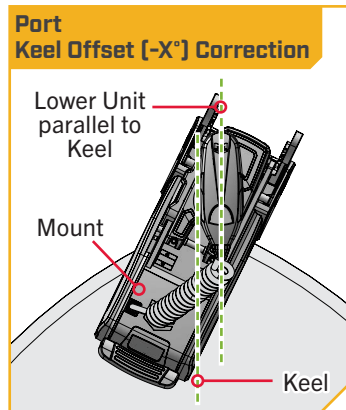
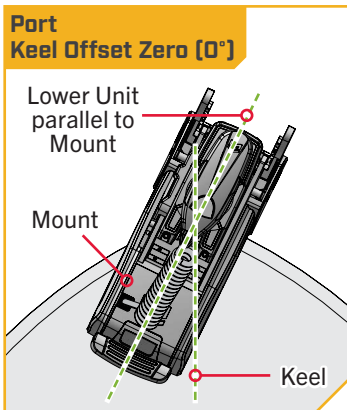



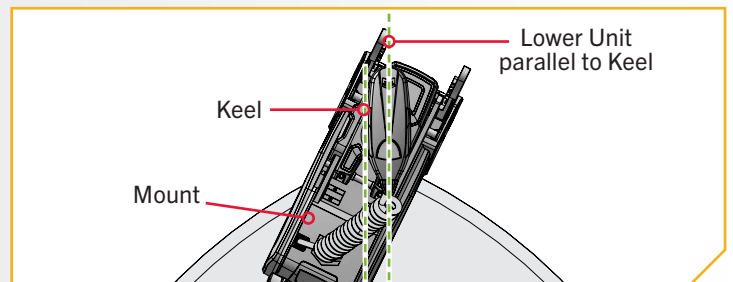

NOTICE: For Ultrex QUEST trolling motors, complete all installation steps before adjusting the Keel Offset. This includes mounting the trolling motor to the deck of the boat, calibrating or rotating the Pedal Control Sleeve Assembly, and installing and securing the power and accessory cables. For more information, follow all of the installation instructions provided in the trolling motor Owner's Manual found online at minnkota.johnsonoutdoors.com.



- 1
 - a. Power on the trolling motor.
 - b. With either the Wireless Remote, foot pedal, or One-Boat Network (OBN) app on a paired mobile device, steer the motor so that the control head and lower unit are parallel to the Keel.







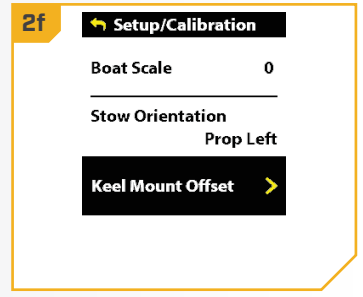
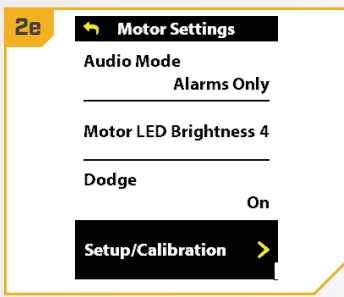
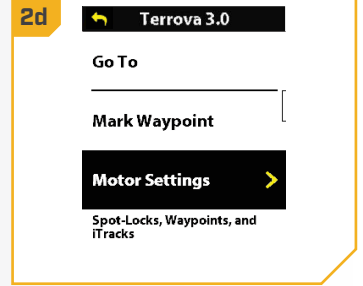

2

- c. Press the Menu  button on the Wireless Remote.
- d. Use the Speed Up  or Speed Down  button to find the Motor Settings menu. Use the Steer Right  button to select Motor Settings.
- e. In the Motor Settings Menu, use the Speed Up  or Speed Down  button to find Setup/Calibration.
- f. In the Setup/Calibration menu, use the Speed Up  or Speed Down  button to find Keel Mount Offset. Use the Steer Right  button to select Keel Mount Offset.



3

- g. Review all safety warnings. Use the Steer Right  button to select Start and begin the process.
- h. Use the Steer Left  or Steer Right  button to point the motor forward and parallel to the Keel.
- i. When satisfied with the placement of the trolling motor, use the Speed Up  or Speed Down  button to scroll to Set. Use the Steer Right  button to select Set. The degree of offset is displayed at the bottom of the Dashboard.

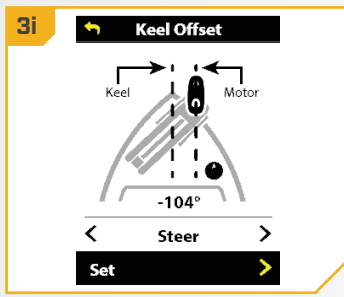
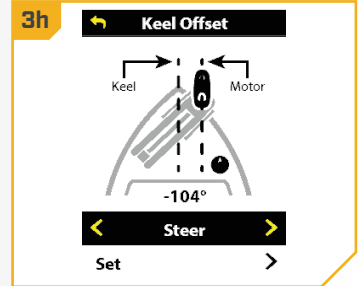
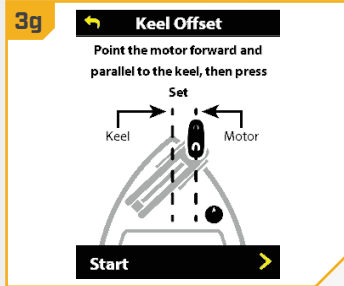





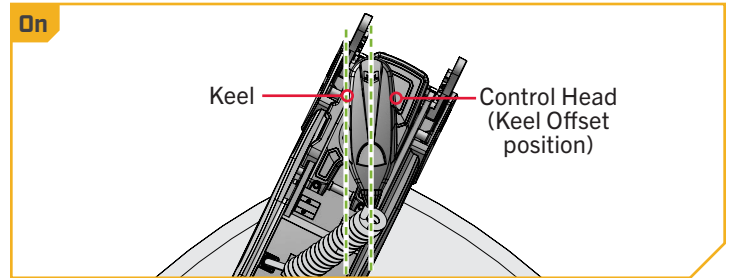
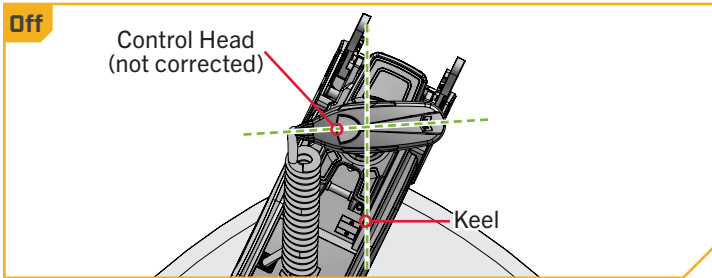

ONE-BOAT NETWORK

› Straight on Deploy

Minn Kota recommends setting the Keel Offset when the position of the Lower Unit is parallel with the Keel. Save the Keel Offset before exploring the Straight on Deploy feature. Straight on Deploy uses the position recorded in Keel Offset to know where to position the Lower Unit to be parallel with the Keel. When Straight on Deploy is engaged, the trolling motor will deploy the motor and automatically rotate the Lower Unit to the position saved to memory in Keel Offset. By default, the Lower Unit will be parallel to the Keel when the Mount is parallel to the Keel. If the Keel Offset was programmed to another angle, the Straight on Deploy feature will correct the position to match the corrected angle when turned “on.” If straight on deploy is turned “off,” the trolling motor will not correct the position in any direction.



- 1
 - a. With the trolling motor powered “on,” press the Menu  button on the Wireless Remote.
 - b. Use the Speed Up  or Speed Down  button to find the Motor Settings menu. Use the Steer Right  button to select Motor Settings.
 - c. In the Motor Settings Menu, use the Speed Up  or Speed Down  button to find Straight on Deploy.
 - d. By default, the Straight on Deploy is toggled “off.”
 - e. Use the Steer Right  button to toggle between “on” and “off.”

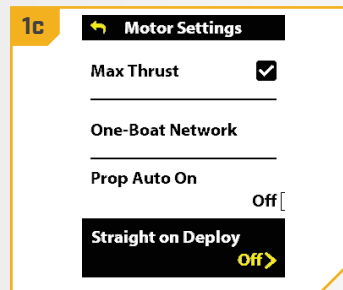
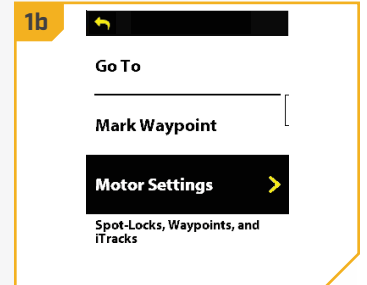

› Stow Orientation

The Stow Orientation is a term used to describe the lower unit and Prop position when the motor is stowed. The factory default for the lower unit is for the Prop to face outboard (Prop Left) on a Port installation. Setting the Stow Orientation allows the installation to be customized to fit boat positioning for either a Port or Starboard installation. Use the setting to configure the Prop left or right to accommodate fishing or trailering applications.

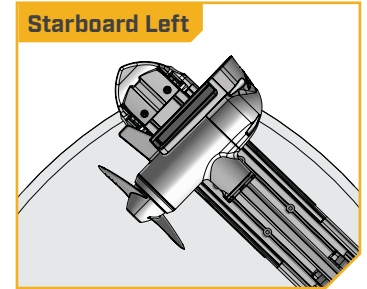
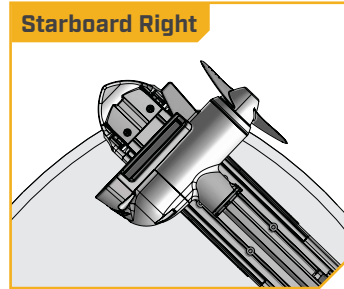
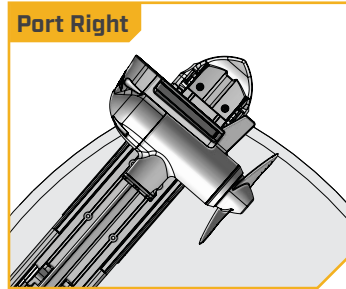
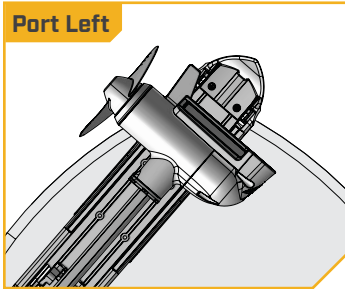

- 1**
 - a. With the trolling motor powered on, press the Menu button.
 - b. Use the Speed Up or Speed Down button to find the Motor Settings menu. Use the Steer Right button to select Motor Settings.
 - c. In the Motor Settings Menu, use the Speed Up or Speed Down button to find Setup/Calibration. Use the Steer Right button to select Setup/Calibration.

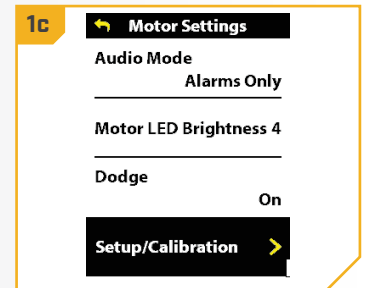
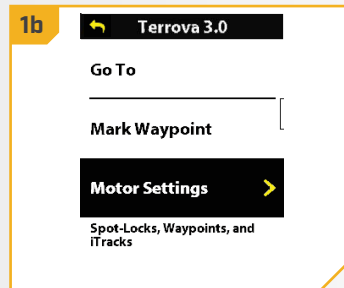

- 2**
 - d. Once in the Setup/Calibration menu, use the Speed Up or Speed Down button to find Stow Orientation. Use the Steer Right button to select Stow Orientation.
 - e. In the Stow Orientation menu, use the Speed Up or Speed Down button to highlight either Prop Left and Prop Right. Use the Steer Right button to make the selection.

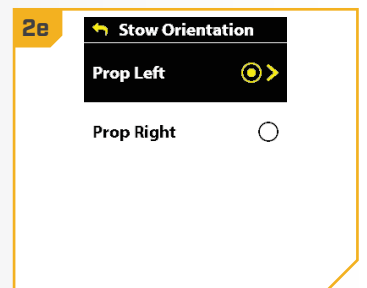
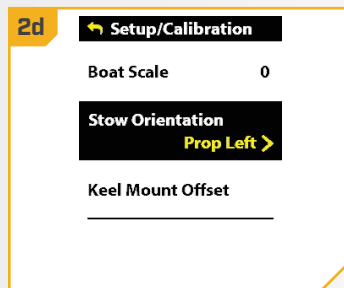

ONE-BOAT NETWORK

› Boat Scale







Trolling motor performance can be impacted by factors including, but not limited to, wind, water conditions, boat specifications, battery health, wiring, etc.

Boat Scale provides a method of adjusting how the trolling motor will perform to account for these and other variables. The Minn Kota trolling motor comes from the factory with Boat Scale set to zero. Boat Scale can be adjusted up (+2) or down (-2) to increase or decrease how the motor control software applies power while using a navigation mode like Spot-Lock.





An example showing the need to reduce Boat Scale would be while using Spot-Lock and the motor is over-correcting or making frequent adjustments. In this case, try reducing Boat Scale to -1 to reduce this behavior. If the behavior continues, reduce Boat Scale to -2.

An example showing the need to increase Boat Scale while using Spot-Lock would be the motor is drifting away from its target location frequently or needs help to make corrections. Try increasing Boat Scale to +1 to help improve the trolling motor accuracy in this case. If the behavior continues, increase Boat Scale to +2.

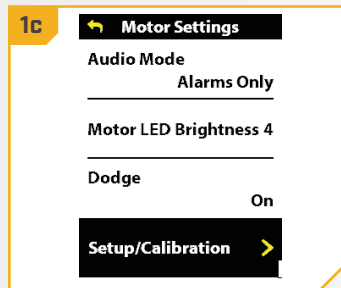
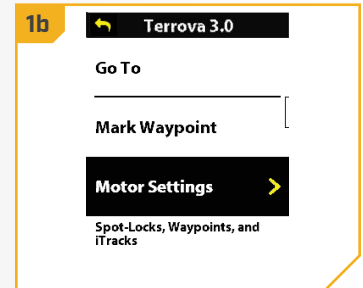
› Adjusting Boat Scale with the Wireless Remote

- 1**
 - a. With the trolling motor powered “on”, press the Menu  button on the Wireless Remote.
 - b. Use the Speed Up  or Speed Down  button to find the Motor Settings menu. Use the Steer Right  button to select Motor Settings.
 - c. In the Motor Settings Menu, use the Speed Up  or Speed Down  button to find Setup/Calibration.



- 2**
 - d. Once in the Setup/Calibration menu, use the Speed Up  or Speed Down  button to find Boat Scale.
 - e. Use the Steer Left  or Steer Right  button to adjust the Boat Scale to one of the five settings: -2, -1, 0, 1 or 2.

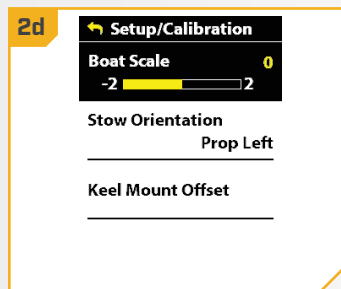

SPOT-LOCK

HOW SPOT-LOCK WORKS

Spot-Lock uses a single point of reference that is recorded when the Spot-Lock button is pressed. The reference point is a set of GPS coordinates that are captured at the location of the motor at the moment the button is pressed. This point is recorded and can be saved into one of the Spot-Lock memory locations. Spot-Lock works by recognizing the GPS coordinates and will automatically navigate the boat to keep it at the Spot-Lock location. If the Advanced GPS Navigation system sees the motor is not positioned at the Spot-Lock location, it will control motor speed and direction in an attempt to keep the motor on the Spot-Lock location.

NOTICE: Spot-Lock is based on the location of the motor, not on the location or direction of the boat. Outside forces such as wind and current will cause the boat to move. Spot-Lock will navigate to maintain the motor on the Spot-Lock location regardless of the position of the boat.

⚠️ WARNING

Watch for a turning Prop when working with Spot-Lock and Go To Spot-Lock. The Prop will automatically turn on when Spot-Lock or Go To Spot-Lock are engaged, even if the engagement is accidental. A turning Prop can cause injury. The Prop will turn "on" for Spot-Lock and Go To Spot-Lock regardless of the Prop Auto On setting.

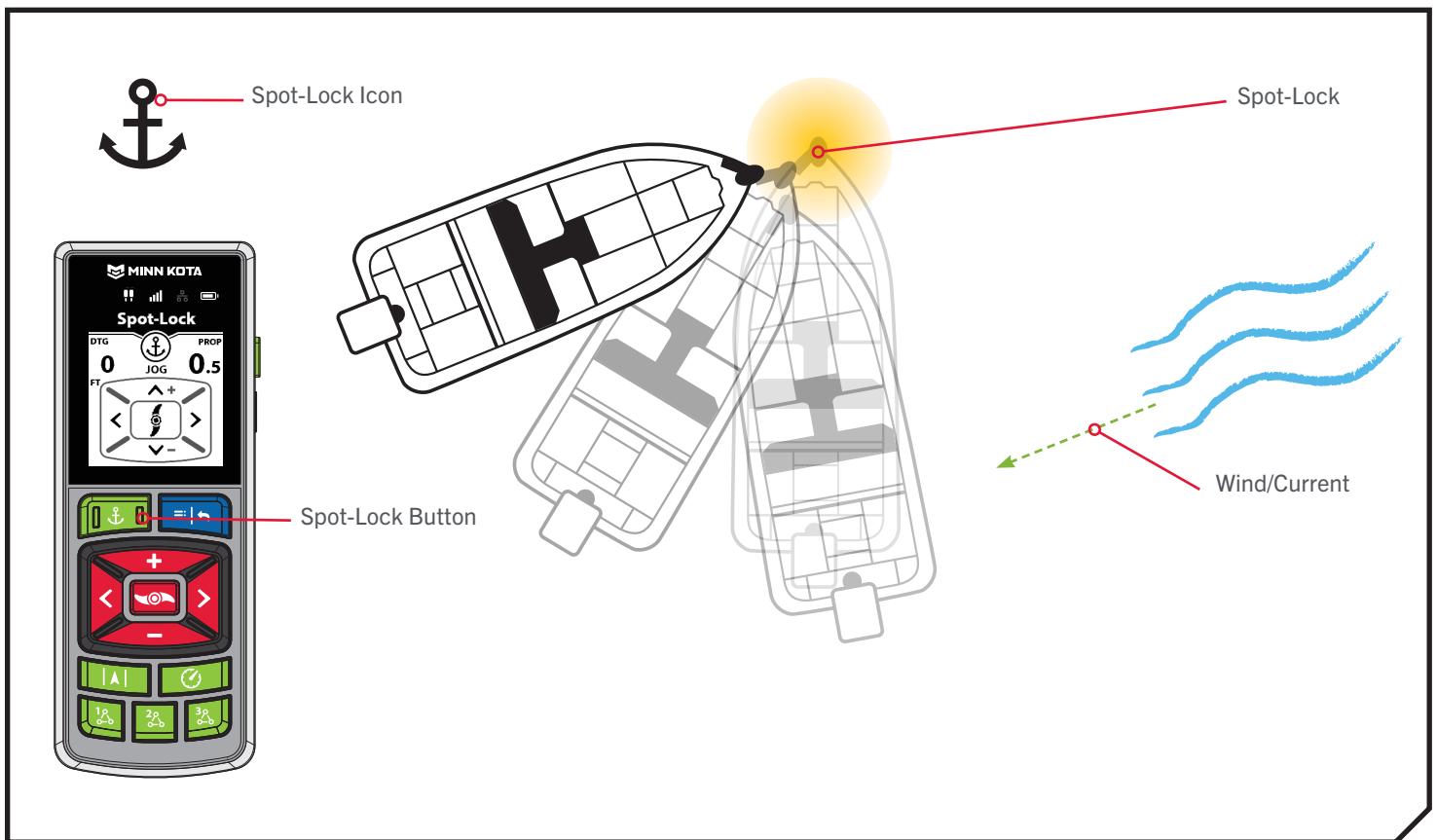



SPOT-LOCK

SPOT-LOCK FUNCTIONS >

> Engaging Spot-Lock

1

- Press the Spot-Lock  button.
- The Spot-Lock Active Band will appear on the Dashboard.
- To save the Spot-Lock, press the Menu  button. Scroll to Save Spot-Lock. Select it by pressing the Steer Right  button.
- A banner will appear at the bottom of the screen for three seconds that displays the Spot-Lock ID.

NOTICE: Up to 20 Spot-Lock or Waypoint locations can be recorded to the Wireless Remote. Once full, the remote will display a Storage Full error screen. See the "My Data" section in this manual for instructions on how to delete data to free up space on the remote. Additional Spot-Lock/Waypoint locations can be saved from the fish finder.

NOTICE: If the Spot-Lock button is accidentally pressed, press the Spot-Lock  button again to cancel Spot-Lock.

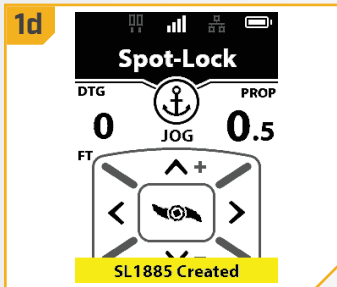
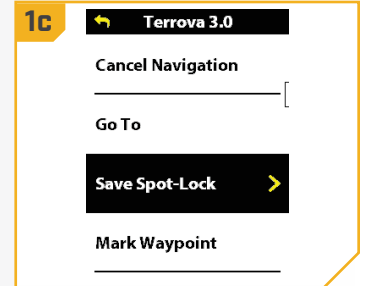
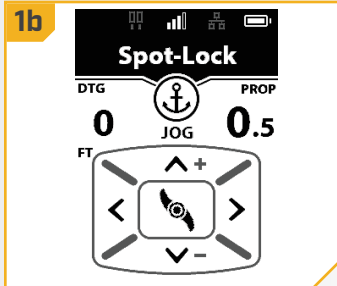

1 Disengaging Spot-Lock

- a. With Spot-Lock engaged, press the Spot-Lock  button on the remote to disengage Spot-Lock.
- b. The Spot-Lock Active Band will disappear from the Dashboard.

OR

- a. Press the Menu  button and then select Cancel Navigation.

OR

- a. Press the Prop button to cancel Spot-Lock.

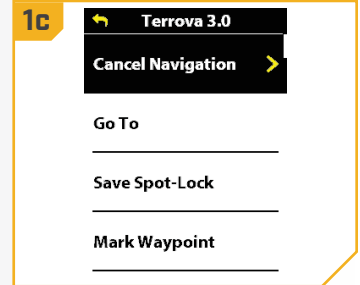





NOTICE: If the motor is equipped with a foot pedal, pressing any button on the foot pedal, changing the prop speed, or manually steering the motor with the foot pedal will disengage Spot-Lock.

SPOT-LOCK

Spot-Lock Jog

Spot-Lock Jog is a feature that is only available with a Heading Sensor. For information on the Heading Sensor, go to the "Heading Sensor" section of this manual. Engaging Spot-Lock Jog allows the current Spot-Lock location to be moved five feet forward, backward, left, or right.

1

- a. To engage Spot-Lock Jog, first engage Spot-Lock. Use the Speed Down  (jog backward), Speed Up  (jog forward), Steer Left  (jog left), and Steer Right  (jog right) buttons to jog the Spot-Lock location 5-feet in the selected direction from the current Spot-Lock location.
- b. As soon as the boat is jogged to the new location, the new location is immediately saved into a temporary Spot-Lock Memory and the boat will relate additional jogging with the temporary Spot-Lock location.

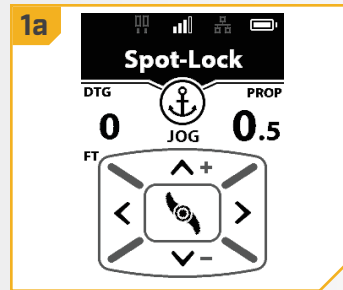
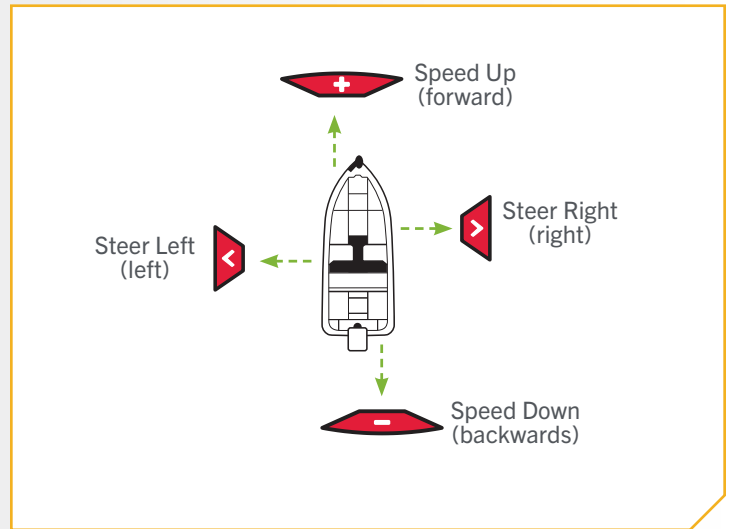

NOTICE: A Heading Sensor is required for Spot-Lock Jog. All QUEST series trolling motors have a built-in Heading Sensor. If your motor does not have a built-in Heading Sensor or is not paired with an external Heading Sensor, an error tone is emitted when the manual navigation buttons are pressed and Spot-Lock will cancel.

NOTICE: Spot-Lock Jog moves the GPS coordinates of the Spot-Lock location based on the orientation of the boat as determined by communication with the Heading Sensor. The Spot-Lock location can be jogged multiple times consecutively. Once the Spot-Lock location has been jogged, the Advanced GPS Navigation system will recognize the new Spot-Lock location, and the system will control the motor to move the boat accordingly. When jogging a saved Spot-Lock, the Spot-Lock location is preserved and a temporary Spot-Lock will be created with the new jogged coordinates. When jogging a temporary Spot-Lock location, the coordinates of the temporary Spot-Lock will change to the new jogged location.



Go To a Saved Spot-Lock

1

- Manually navigate the boat to within a quarter mile of the saved Spot-Lock location.
- Press the Menu  button.
- Select the Go To menu by pressing the Steer Right  button.
- Select Spot-Locks by pressing the Steer Right  button.

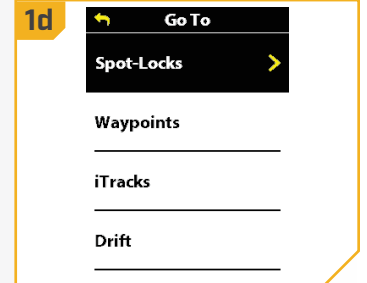
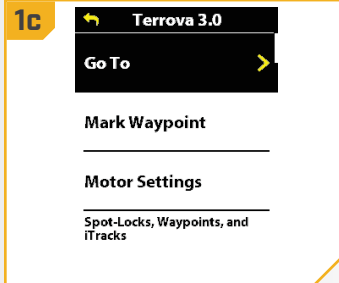



NOTICE: The Go To feature can also be activated from a One-Boat Network (OBN) button. Go To is the default for the OBN 2  button. See One-Boat Network Buttons for more information on customizing the programmable buttons. See the "One-Boat Network" section for more information.



WARNING

Due to safety reasons, the Advanced GPS Navigation system will not re-engage a saved Spot-Lock location greater than a quarter mile away.

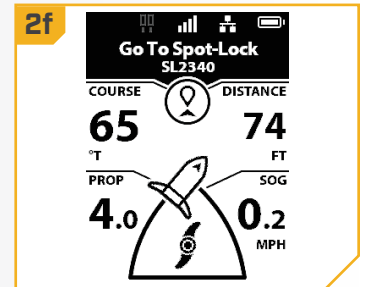
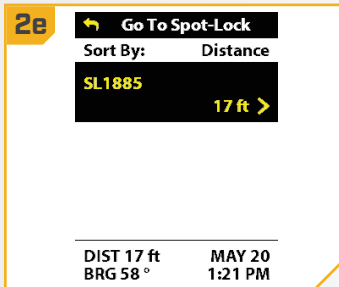

2

- A list of Spot-Locks that are within a quarter mile will appear. Use the Speed Up  and Speed Down  buttons to scroll through the list of Spot-Locks to find a Spot-Lock to navigate to. Select it by pressing the Steer Right  button.
- The Go To Spot-Lock Active Band will appear on the Dashboard until the Spot-Lock has been reached.



Disengage Go To Spot-Lock

1

- While Go To Spot-Lock is engaged, press the Menu  button.
- Select Cancel Navigation by pressing the Steer Right  button.
- The Go To Spot-Lock Active Band will disappear from the Dashboard.

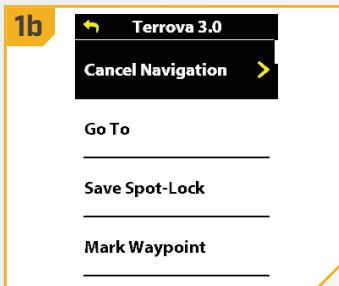

DRIFT MODE

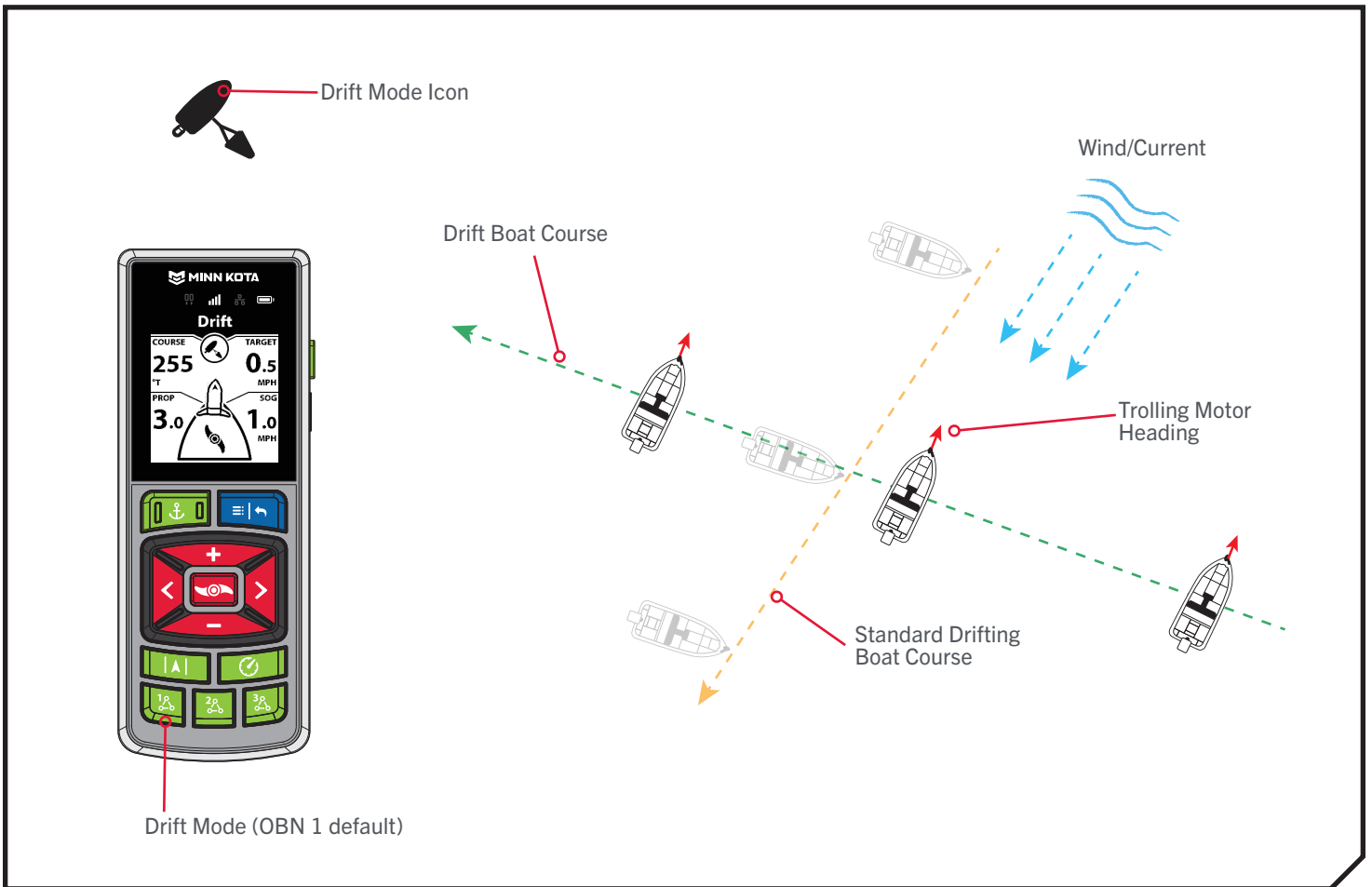

HOW DRIFT MODE WORKS

When Drift Mode is engaged, the Advanced GPS Navigation system maintains a desired straight line course and target speed even if the course direction is influenced by wind, current, or other outside influences. Simply point the motor in the intended navigation direction and press Drift Mode, then adjust to the desired target speed over ground (SOG). Drift Mode will take control to allow you to focus entirely on fishing whether it's casting a targeted area, trolling crankbaits or maintaining a slow and controlled drift over specific cover or structure, even when traveling with or across wind or current. Easily make fine adjustments to the target speed or the target course or reverse it completely on the fly at any time.



DRIFT FUNCTIONS >

> Engaging Drift Mode

- 1
 - a. Press the Menu  button.
 - b. Select the Go To menu by pressing the Steer Right  button.
 - c. Select Drift by pressing the Steer Right  button.
 - d. The Drift Mode Active Band will display on the Dashboard.



OR

 - a. Press the OBN 1  button.
 - b. The Drift Mode Active Band will display on the Dashboard.

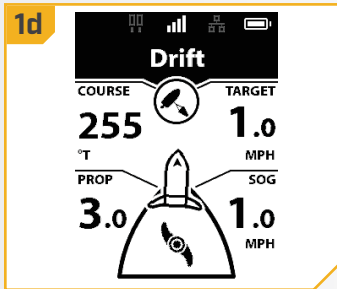
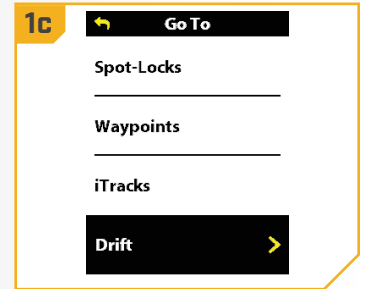
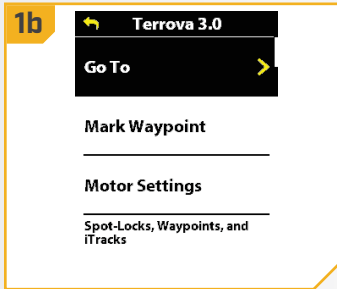
NOTICE: SOG refers to Speed Over Ground. SOG is the speed the boat is actually traveling. Target Speed is the intended Cruise Control speed.



> Disengaging Drift Mode

- 1
 - a. When Drift is engaged, press the Menu  button.
 - b. Select Cancel Navigation by pressing the Steer Right  button.
 - c. The Drift Active Band will disappear from the Dashboard.



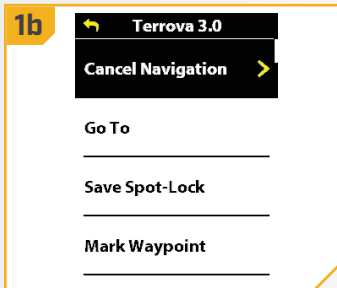

NOTICE: Canceling Drift Mode Navigation does not turn off the prop. The prop will continue to spin.



DRIFT MODE

Drift Mode Adjusting Course - Angle

1

- When Drift Mode is engaged, press the Menu  button and scroll to Adjust Course.
- Select Adjust Course by pressing the Steer Right  button.
- Scroll to the Angle option and press the Steer Left  or Steer Right  button to adjust the course by 5-degree increments.
- The new Course will be updated on the Dashboard.



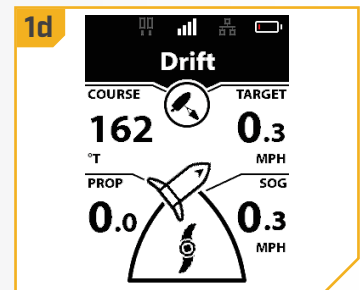
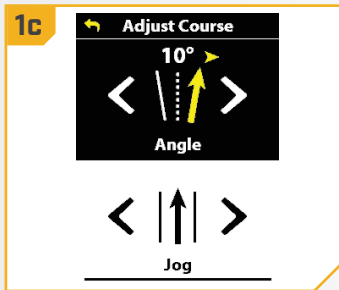
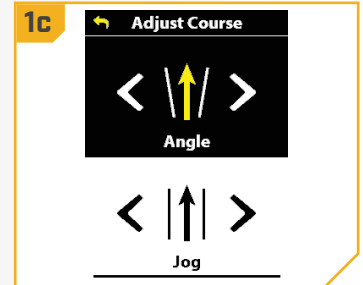
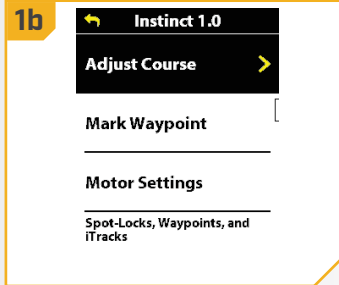

NOTICE: When Drift is engaged, press the OBN 1  button again to quickly display the Adjust Course menu.



Drift Mode Jog

Drift Mode Jog allows the Drift course to be adjusted to the left or right and still maintain the same course.

1

- When Drift Mode is engaged, press the Menu  button and scroll to Adjust Course.
- Select Adjust Course by pressing the Steer Right  button.
- Scroll to the Jog option and press the Steer Left  or Steer Right  button to adjust the course by 5-foot increments.
- The new Course will be updated on the Dashboard.

NOTICE: When Drift is engaged, press the OBN 1  button again to quickly display the Adjust Course menu.

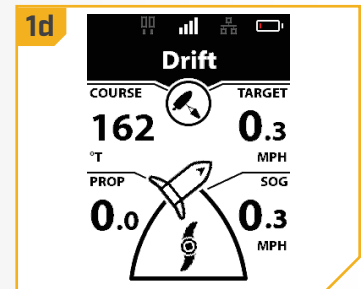
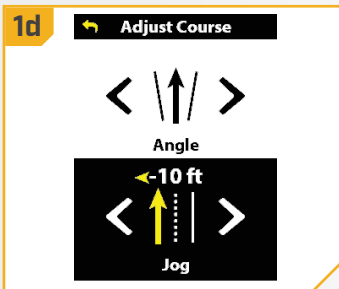
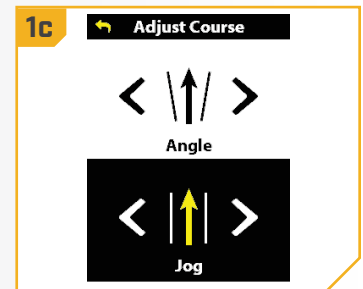
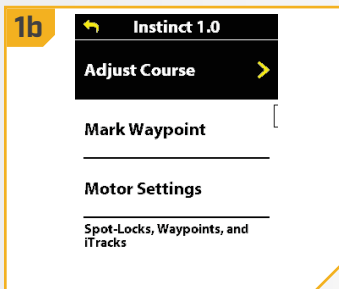

Reverse Drift Mode

Reverse Drift Mode allows the user to change target course to the opposite direction of travel.

- 1 a. When Drift Mode is engaged, press the Menu button.
- b. Use the Speed Up or Speed Down button to scroll to Reverse Navigation, and select it by pressing the Steer Right button.



DODGE MODE

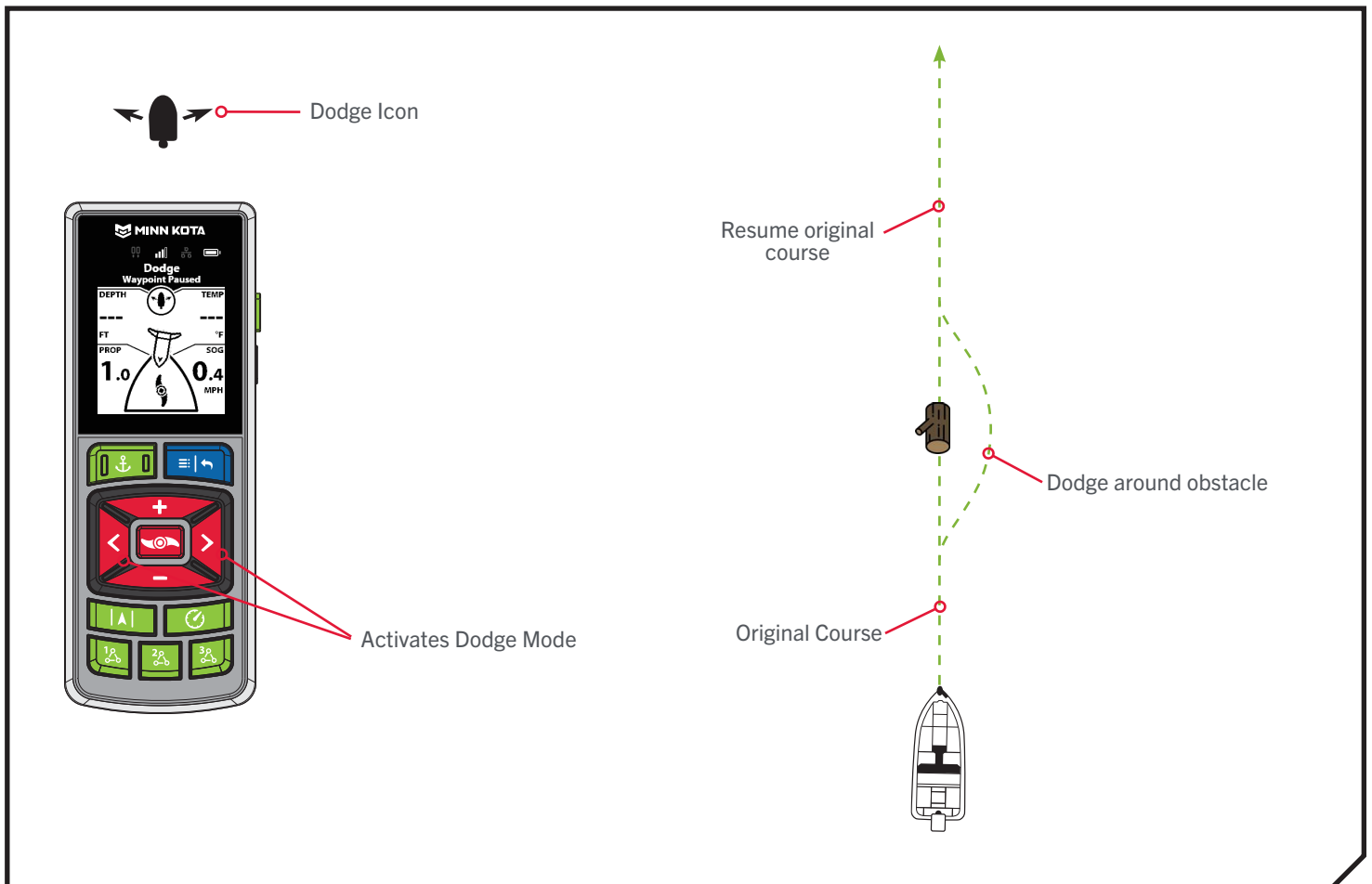

HOW DODGE MODE WORKS

Dodge Mode allows you to temporarily suspend select forms of navigation while allowing you to manually control steering and prop speed to steer around an obstacle without canceling navigation, and then easily resume the previously suspended form of navigation. Dodge Mode is available during Drift Mode, GoTo Spot Lock, GoTo Waypoint, GoTo iTrack, GoTo Route, Circle Mode, Follow the Contour, and Follow the Shoreline. Dodge Mode will default to “on.”









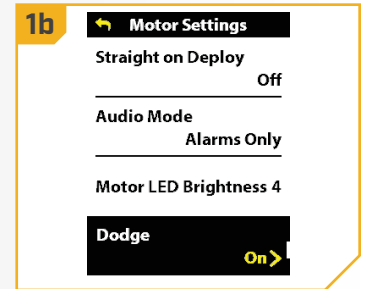
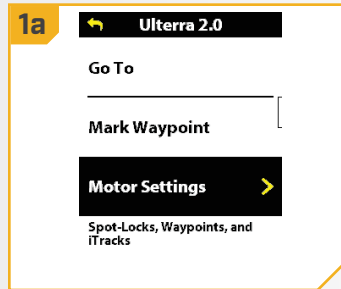



WORKING WITH DODGE MODE >

> Turning Dodge Mode On/Off

- 1
 - a. Press the Menu  button and select Motor Settings by pressing the Steer Right  button.
 - b. Scroll to Dodge and press the Steer Right  button to toggle “on” or “off.”



> Engaging and Disengaging Dodge Mode

- 1
 - a. While actively navigating a course, press the Steer Left  or Steer Right  button to pause navigation and engage Dodge Mode.
 - b. Use the Steer Left  or Steer Right  buttons to steer around the obstruction.
 - c. Use the Speed Up  and Speed Down  buttons to control prop speed while in Dodge Mode.
 - d. To resume navigation while in Dodge Mode, press the Menu  button.
 - e. Use the Speed Up  or Speed Down  button to scroll to Resume Navigation, and select it by pressing the Steer Right  button.

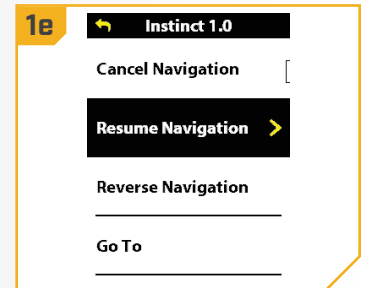
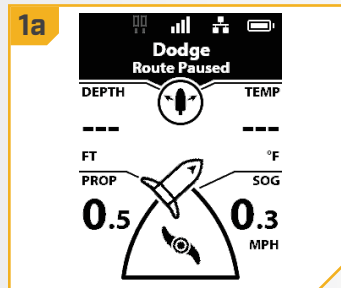

WAYPOINTS

WORKING WITH WAYPOINTS

Waypoints are saved latitude/longitude positions. They mark a position of interest such as your favorite fishing area, structure or marker buoy. Waypoints work similarly to Spot-Locks. When the Advanced GPS Navigation system navigates Waypoints, the system takes control over all steering functions. Speed can be controlled manually or through the Cruise Control function. For more information on how to work with Waypoints, please see your Humminbird manual.

WARNING

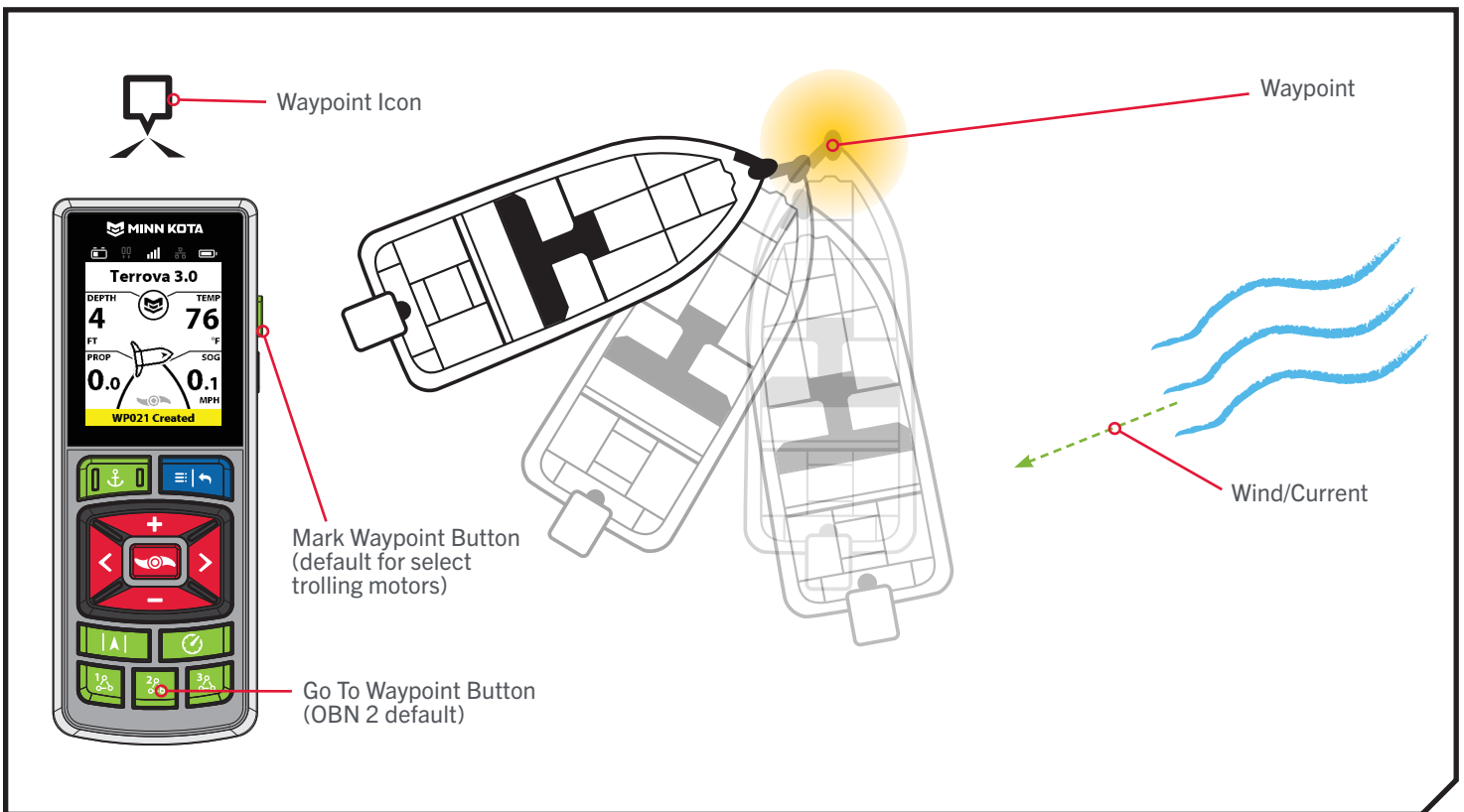

Watch for a turning Prop when working with Waypoints. Auto Prop On is set to "off" by default. If Auto Prop On is turned "on," the Prop will automatically turn on when a Waypoint is engaged, even if the engagement is accidental. A turning Prop can cause injury. If Auto Prop On is turned "off," the Prop must be enabled before the boat will begin navigating to a Waypoint.



WAYPOINT FUNCTIONS >

> Mark a Waypoint

1

- a. Press the Menu  button.
- b. Scroll to Mark Waypoint. Select it by pressing the Steer Right  button.
- c. A banner will appear at the bottom of the screen for three seconds that displays the Waypoint ID.

OR

- a. On select trolling motors, press the OBN  side button.
- b. A banner will appear at the bottom of the screen for three seconds that displays the Waypoint ID.

NOTICE: Up to 20 Spot-Lock or Waypoint locations can be recorded to the Wireless Remote. Once full, the remote will display a Storage Full error screen. See the "My Data" section in this manual for instructions on how to delete data to free up space on the remote. Additional Spot-Lock/Waypoint locations can be saved from the fish finder.

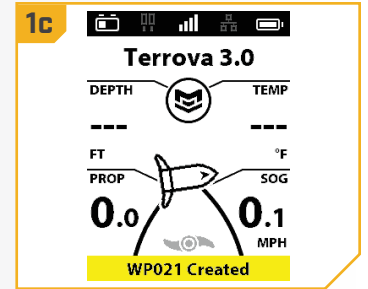
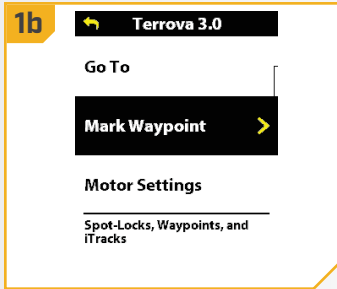





NOTICE: Mark a Waypoint is set as the default for the OBN Side button on all motors that do NOT have the auto stow/deploy or adjust trim feature. For Ulterra, Ulterra QUEST, and RT Instinct QUEST models, the default OBN Side button is set to Deployment Mode. See the "One-Boat Network" section to learn how to program Mark a Waypoint to a OBN button.

WAYPOINTS

Go To a Saved Waypoint

1

- Manually navigate the boat to within a quarter mile of the saved Waypoint.
- Press the Menu  button.
- Select the Go To menu by pressing the Steer Right  button.
- Select Waypoints by pressing the Steer Right  button.

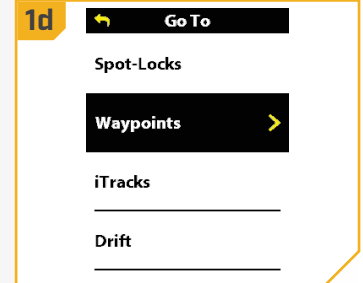
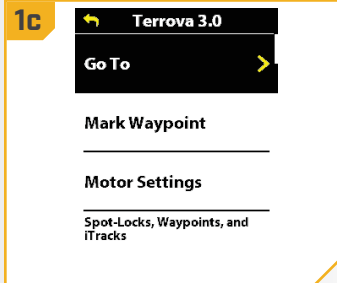

NOTICE: The Go To feature can also be activated from a One-Boat Network (OBN) button. Go To is the default for the OBN 2  button. See One-Boat Network Buttons for more information on customizing the programmable buttons. See the "One-Boat Network" section for more information.



WARNING

To ensure safety, the Advanced GPS Navigation system will not re-engage a saved Waypoint location greater than a quarter mile away.

2

- A list of Waypoints that are within a quarter mile will appear. Use the Speed Down  and Speed Up  buttons to scroll through the list of Waypoints to find a Waypoint to navigate to and select it by pressing the Steer Right  button.
- The Waypoint Active Band will appear in the Dashboard.

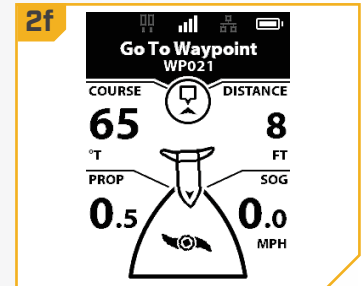
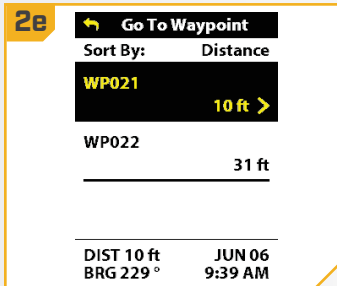

NOTICE: If the Prop is not turning, be sure to press the Prop Button  to enable it. The Prop behavior for Go To Waypoint can be changed with the Prop Auto On setting. Read "To Toggle the Prop Auto On" section of this manual for more information.

NOTICE: You are able to select an Arrival Mode for Go To Waypoint in the Motor Settings menu "Arrival Mode." See the "Change the Arrival Mode" section of this manual for more information.



NOTICE: There is full control over motor speed while navigating to a Waypoint.

1 Disengage Go To Waypoint

- a. When Go To Waypoint is engaged, press the Menu  button.
- b. Select Cancel Navigation by pressing the Steer Right  button.
- c. The Go To Waypoint Active Band will disappear from the Dashboard.

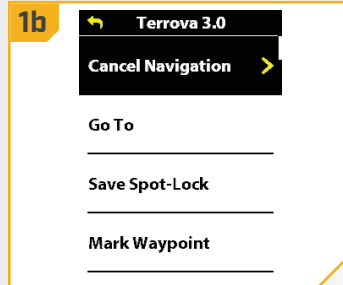

CRUISE CONTROL

CRUISE CONTROL

During regular operation of the Advanced GPS Navigation system, the user can control Prop speed. The controller will communicate the Speed Over Ground (SOG) to the remote and the remote will display it. The SOG is the speed that the boat is traveling and will vary based on environmental factors such as wind and current, even if the Prop speed remains the same. Cruise Control helps to compensate for the variety of external forces that affect the SOG and keeps the boat traveling at an even speed. When Cruise Control is engaged, the current SOG becomes the Target Speed. Cruise Control automatically controls the Prop speed to match the Speed Over Ground to the Target Speed.



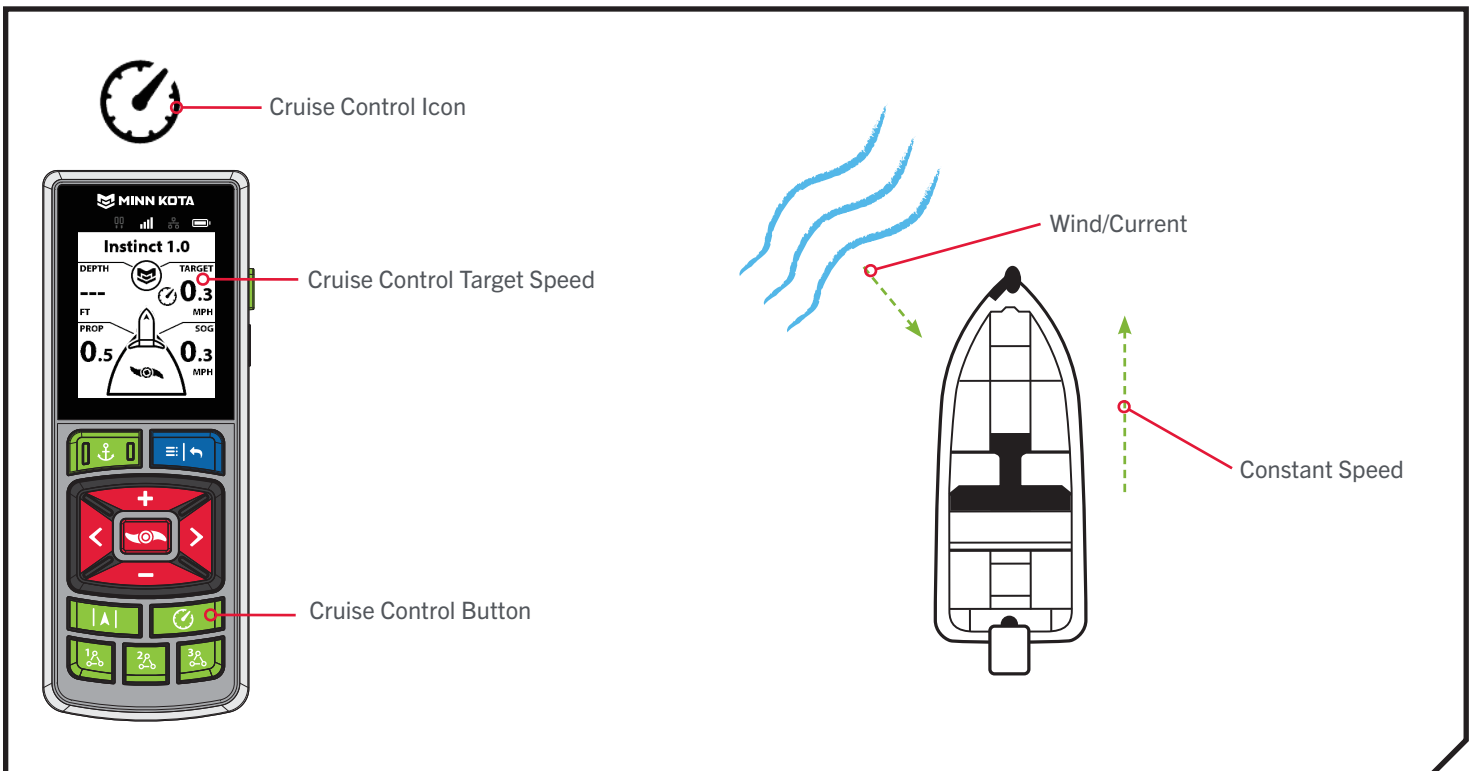

WARNING

A turning Prop can cause injury. Watch for a turning Prop when Cruise Control is engaged. The Prop will automatically turn on when Cruise Control is engaged, even if the engagement is accidental. Be mindful of the Prop when engaging Cruise Control to prevent injury. The Prop will turn on regardless of the Auto Prop On setting. If the Prop is not "on" before the Cruise Control is engaged, it will be turned "on," or enabled and run at the current speed setting.



WORKING WITH CRUISE CONTROL >

> Engaging Cruise Control

- 1
 - a. Press the Cruise Control  button.
 - b. Once Cruise Control is engaged, the Cruise Control  icon will display on the Dashboard.
 - c. The Target Speed can be increased and decreased using the Speed Up  and Speed Down  buttons. The Prop speed will adjust accordingly based on the current conditions.

NOTICE: SOG refers to Speed Over Ground. SOG is the speed the boat is actually traveling. The Target Speed is the intended Cruise Control speed.

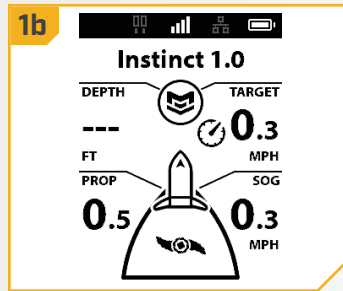

> Disengaging Cruise Control

- 1
 - a. When Cruise Control is engaged, press the Cruise Control  button to disengage.
 - b. The Cruise Control Target Speed and Cruise Control icon will disappear from the Dashboard.

NOTICE: If Cruise Control is engaged, making adjustments to motor speed from the Foot Pedal or engaging Max Speed will cancel Cruise Control.

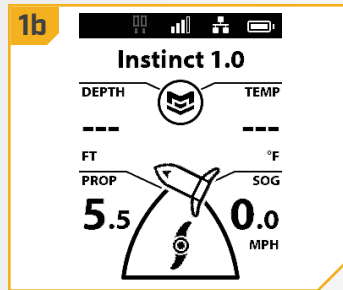

MAX SPEED

MOTOR SPEED AND MAX SPEED

Max Speed sets the Prop speed to Speed 10 when engaged and returns to the previously set speed when disengaged. Max Speed can be engaged regardless of what the current Prop speed is.

Max Speed can only be engaged if the function is assigned to one of the One-Boat Network buttons. See the "One-Boat Network" section of this manual for information on how to customize the One-Boat Network buttons.

WARNING

Watch for a turning Prop when Max Speed is engaged. A turning Prop can cause injury. Max Speed will automatically turn the Prop Speed to Speed 10, even if the engagement is accidental. Max Speed is not affected by Prop Auto On.

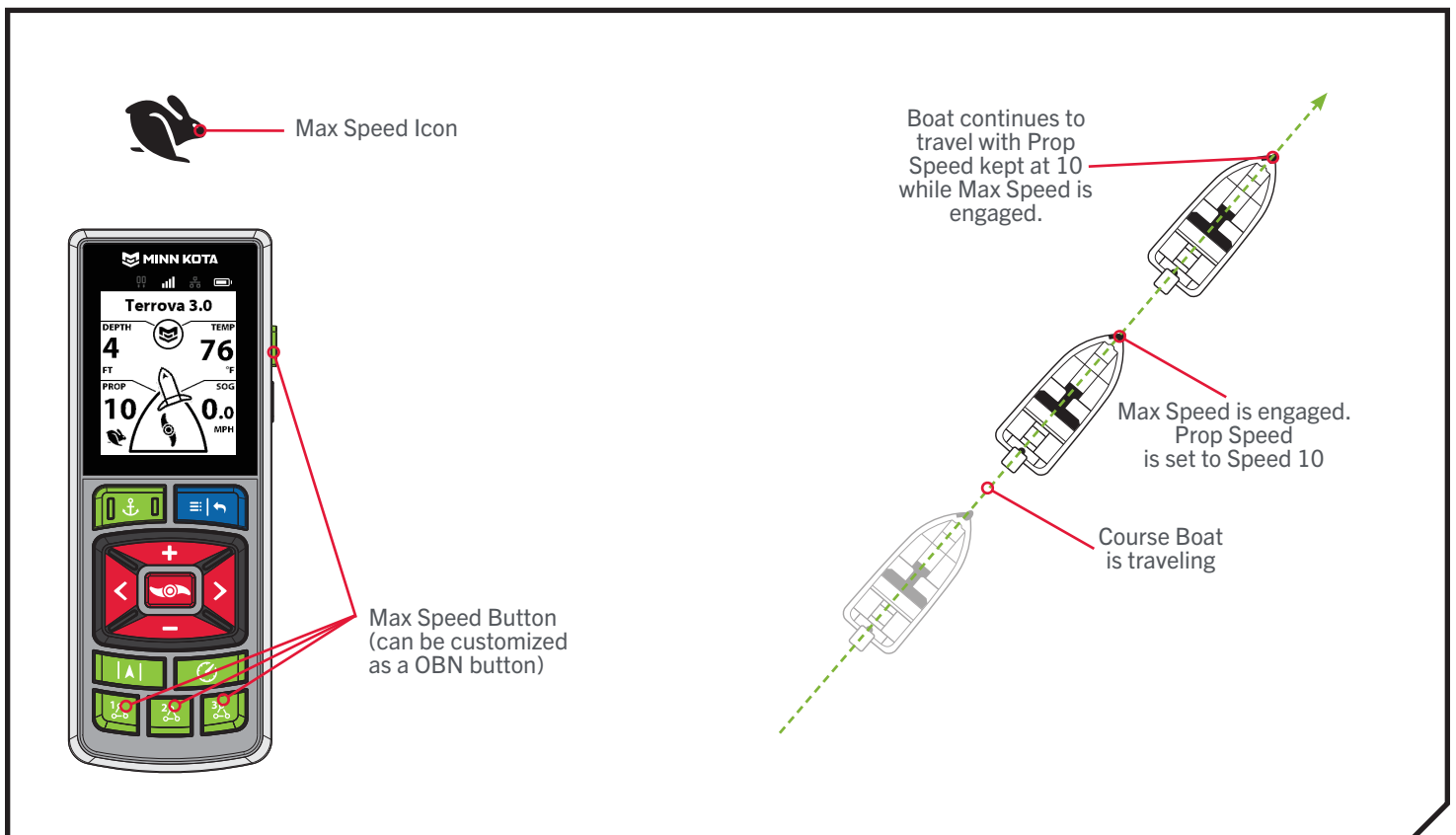

CONTROLLING MAX SPEED >

> Engaging Max Speed

NOTICE: Max Speed must first be programmed as a One-Boat Network (OBN) button. To learn more about programming OBN buttons, see the "One-Boat Network" section of this manual.

- 1 a. Double press the OBN  button that is programmed to Max Speed.
- b. Once Max Speed is engaged, the Max Speed icon will appear on the Dashboard and the Prop Speed will be immediately be set to Speed 10.

NOTICE: Max Speed requires a double press to engage.

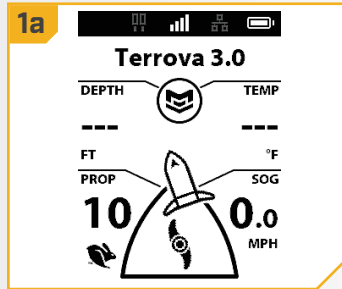

> Disengaging Max Speed

- 1 a. When Max Speed is engaged, press the One-Boat Network button that is programmed for Max Speed once to disengage.
- b. The Max Speed icon will disappear from the Dashboard and the Prop will return to the previous speed.

NOTICE: Manually adjusting the speed below speed 10 or engaging Cruise Control will also disengage Max Speed.

AUTOPILOT

ADVANCED GPS NAVIGATION SYSTEM AND AUTOPILOT

AutoPilot is an Advanced GPS Navigation feature that allows the user to control heading or course. While engaged, adjustments can be made on the fly simply by making a steering adjustment to re-establish their heading or course.

AUTOPILOT MODES

Two different modes of AutoPilot are available: Locked Course AutoPilot and Locked Heading AutoPilot. Both are collectively referred to as AutoPilot. There are distinct differences between the two AutoPilot Modes and how they control the boat. Both Locked Course AutoPilot and Locked Heading AutoPilot are valuable tools anglers can use for accurate and precise bait presentation. Minn Kota highly recommends getting on the water and trying both Locked Course AutoPilot and Locked Heading AutoPilot in various fishing situations and applications. With experimentation and time you will find which AutoPilot Mode works best in any given situation.

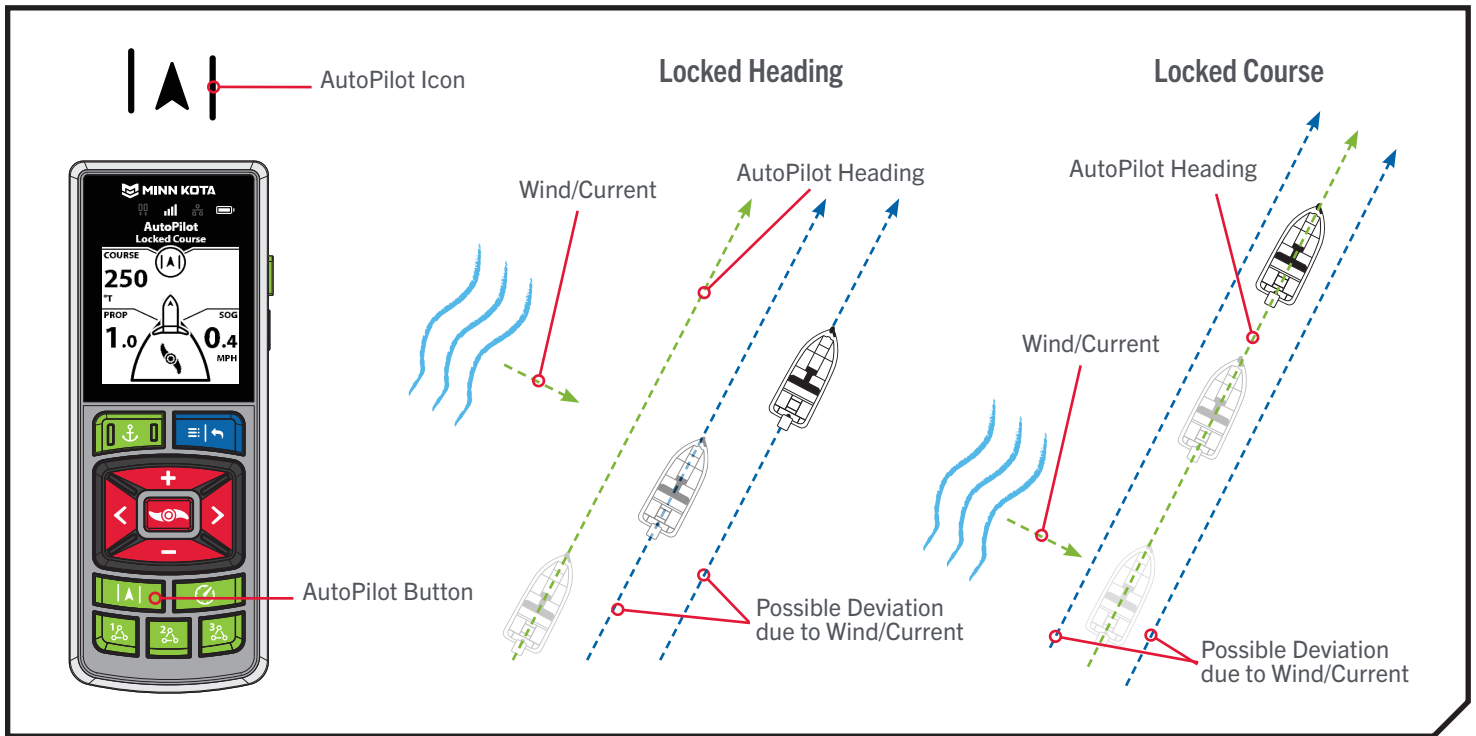

› Locked Heading AutoPilot

AutoPilot uses an internal compass to provide heading lock. When Locked Heading AutoPilot is on, it keeps the motor pointed in the same compass direction. If a manual steering correction is made, Locked Heading AutoPilot locks onto the new compass heading to which the boat was steered. This method of heading tracking does not take into account external forces such as a side wind or currents, which can allow side drift.

› Locked Course AutoPilot

Locked Course AutoPilot not only uses compass heading but also GPS data to correct for cross winds, current and other external forces to keep the boat on the intended course. When Locked Course AutoPilot is turned on, it creates a course that it will follow. When the user steers to a new heading, a new course is created. Locked Course AutoPilot will keep the boat on the course in most conditions. When very extreme conditions exist, such as very strong winds or currents, the trolling motor may not have enough power to control the boat smoothly. In these extreme cases, it may be best to use Locked Heading AutoPilot and let the boat move with the wind or current if the motor is not powerful enough to overcome it.

WORKING WITH AUTOPILOT >

> Engaging AutoPilot

1

- a. Press the AutoPilot  button.
- b. The AutoPilot Active Band will appear on the Dashboard. Either Locked Heading AutoPilot or Locked Course AutoPilot will be engaged depending on the AutoPilot Mode selected.
- c. To adjust the desired heading, manually steer the motor to the new heading. The Advanced GPS Navigation system will automatically lock onto the new heading.

NOTICE: If the Prop is not turning or is flashing, be sure to press the Prop On/Off  button to enable it. The Prop behavior for AutoPilot can be changed with the Prop Auto On setting. Read "To Toggle the Prop Auto On" section of this manual for more information.

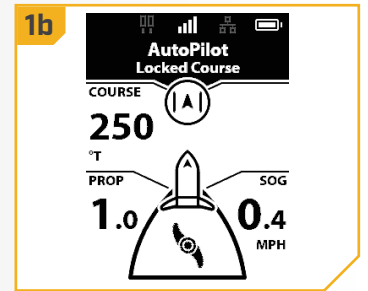
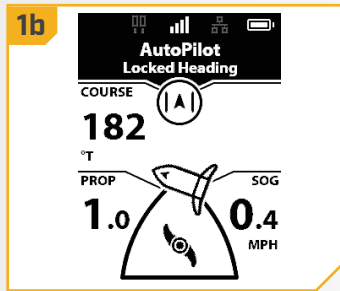

NOTICE: After steering to a new direction, there is a short delay before the direction is locked in to allow the compass to stabilize.

 **CAUTION**

This unit uses a magnetic compass to detect direction of travel. The compass can be adversely affected by magnets or large, ferrous metal objects near (within 24" of) the trolling motor control head.

Obstructions on the Prop may cause excessive vibration of the motor head. This vibration can cause the compass to wander and erratic steering to occur. Clear the obstruction to return the motor to normal operation.

NOTICE: When AutoPilot is on and the trolling motor is pulled out of the water to the stow position, the Prop will continue to run until the motor is 45 degrees away from vertical or until the motor is trimmed high enough, depending on the motor model.





AUTOPILOT

› To Set the Default AutoPilot Mode





AutoPilot has two modes:

1. Locked Heading - This method of heading tracking does not take into account external forces such as a side wind or currents, which can allow side drift.
2. Locked Course - This method of AutoPilot not only uses compass heading but also GPS signal data to correct for cross winds, current and other external forces to keep the boat on the intended course. Except when using Cruise Control, motor speed may need to be adjusted in order overcome outside influence like wind and current.

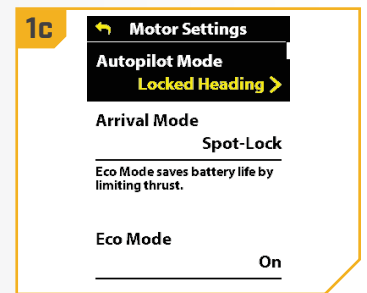
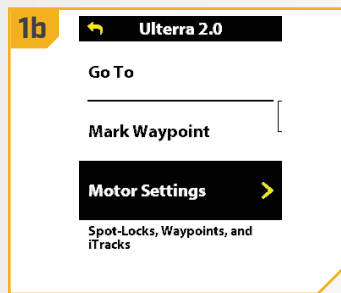
Once it is determined which AutoPilot Mode to operate in, use the following instructions to set it as the default.

- 1
 - a. Press the Menu  button.
 - b. Use the Speed Up  or Speed Down  button to find the Motor Settings menu. Use the Steer Right  button to select Motor Settings.
 - c. Select AutoPilot Mode by pressing the Steer Right  button.





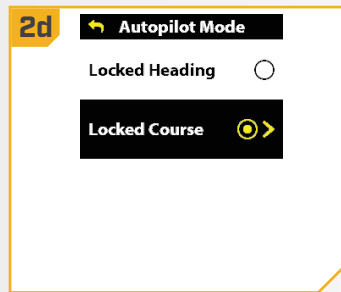

- 2
 - d. Once in the AutoPilot Mode menu, use the Speed Up  and Speed Down  buttons to scroll and select either Locked Heading or Locked Course.
 - e. Press the Steer Right  button to make a selection. The circle to the right of the selected function will be colored in yellow when selected.
 - f. To exit the menu, press and hold the Menu/Back  button.



› AutoPilot Adjust Course - Angle



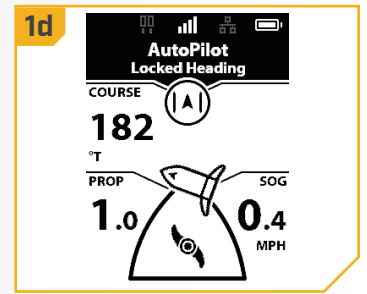
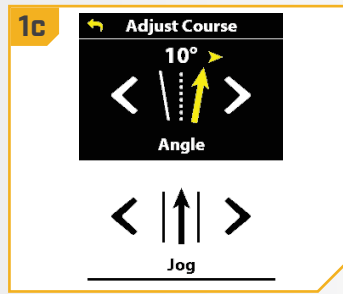
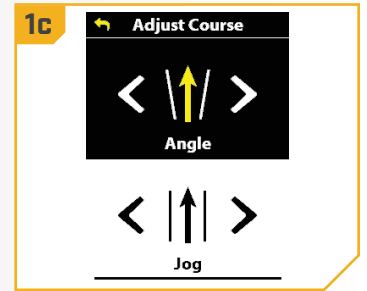
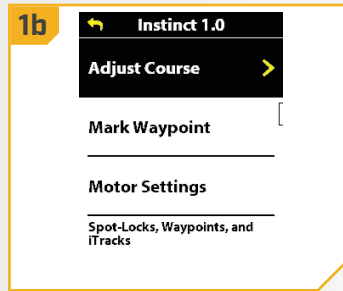

The angle from the current intended course can be adjusted in 5 degree increments.

- 1**
 - a. When AutoPilot is engaged, press the Menu  button and scroll to Adjust Course.
 - b. Select Adjust Course by pressing the Steer Right  button.
 - c. Scroll to the Angle option and press the Steer Left  or Steer Right  button to adjust the course by 5-degree increments.
 - d. The new Course will be updated on the Dashboard.



› AutoPilot Adjust Course - Jog for Locked Course AutoPilot

AutoPilot Jog allows the AutoPilot course to be temporarily adjusted to the left or right. AutoPilot Jog is only available in Locked Course AutoPilot.

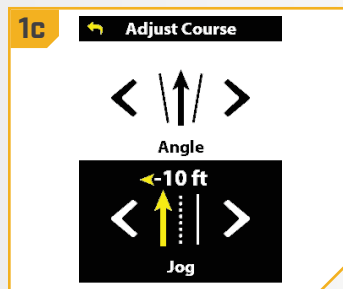
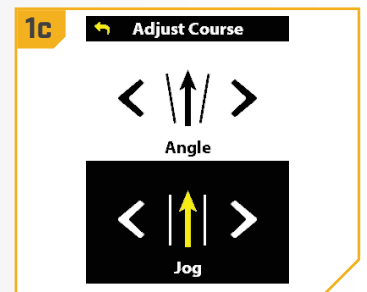
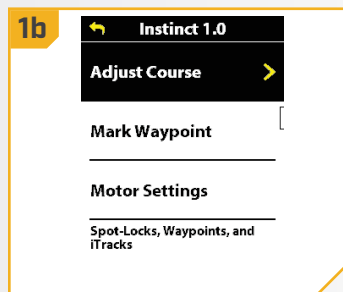

- 1**
 - a. When AutoPilot is engaged, press the Menu  button and scroll to Adjust Course.
 - b. Select Adjust Course by pressing the Steer Right  button.
 - c. Scroll to the Jog option and press the Steer Left  or Steer Right  button to adjust the course by 5-foot increments.



AUTOPILOT

› Disengaging AutoPilot

1

- a. When AutoPilot is engaged, press the AutoPilot  button to disengage.
- b. The AutoPilot Active Band will disappear from the Dashboard.
- c. AutoPilot can also be disengaged by pressing the Menu  button, and then selecting Cancel Navigation by pressing the Steer Right  button.

NOTICE: Pressing the AutoPilot button on the Foot Pedal also disengages AutoPilot.

1b

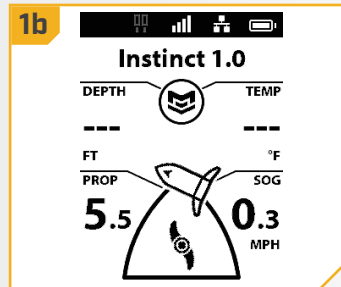

NOTICE: Disengaging AutoPilot does not turn off the prop. The prop will continue to spin.

iTRACKS

UNDERSTANDING iTRACKS

The Advanced GPS Navigation system can be used to record sets of points that make up an iTrack. When recording an iTrack, the Advanced GPS Navigation system starts to record GPS position data in the form of Track Points. The very first Track Point recorded is called the Start, and the last point recorded is called the End. The system sees a recorded series of Track Points as an iTrack. iTracks can be recorded and navigated. When the Go To iTrack Button is pressed, an iTrack can be navigated To Start or To End. The system will navigate to the nearest Track Point and then navigate to the Start or End as requested. Once the nearest Track Point is reached, it will then follow the Track Points in sequence back to either the Start or End based on the selection made. Once the Start or End is reached, the system automatically transitions to the set Arrival Mode. During iTrack navigation, the Advanced GPS Navigation system takes control over all steering functions; speed can be manually controlled or the Cruise Control function can also be used. The motor speed must be set high enough in order to stay on the track given wind, current and other external forces.

WARNING

Watch for a turning Prop when working with iTracks. Auto Prop On is set to "off" by default. If Auto Prop On is turned "on," the Prop will automatically turn on when an iTrack is engaged, even if the engagement is accidental. A turning Prop can cause injury. If Auto Prop On is turned "off," the Prop must be enabled before the boat will begin navigating an iTrack.

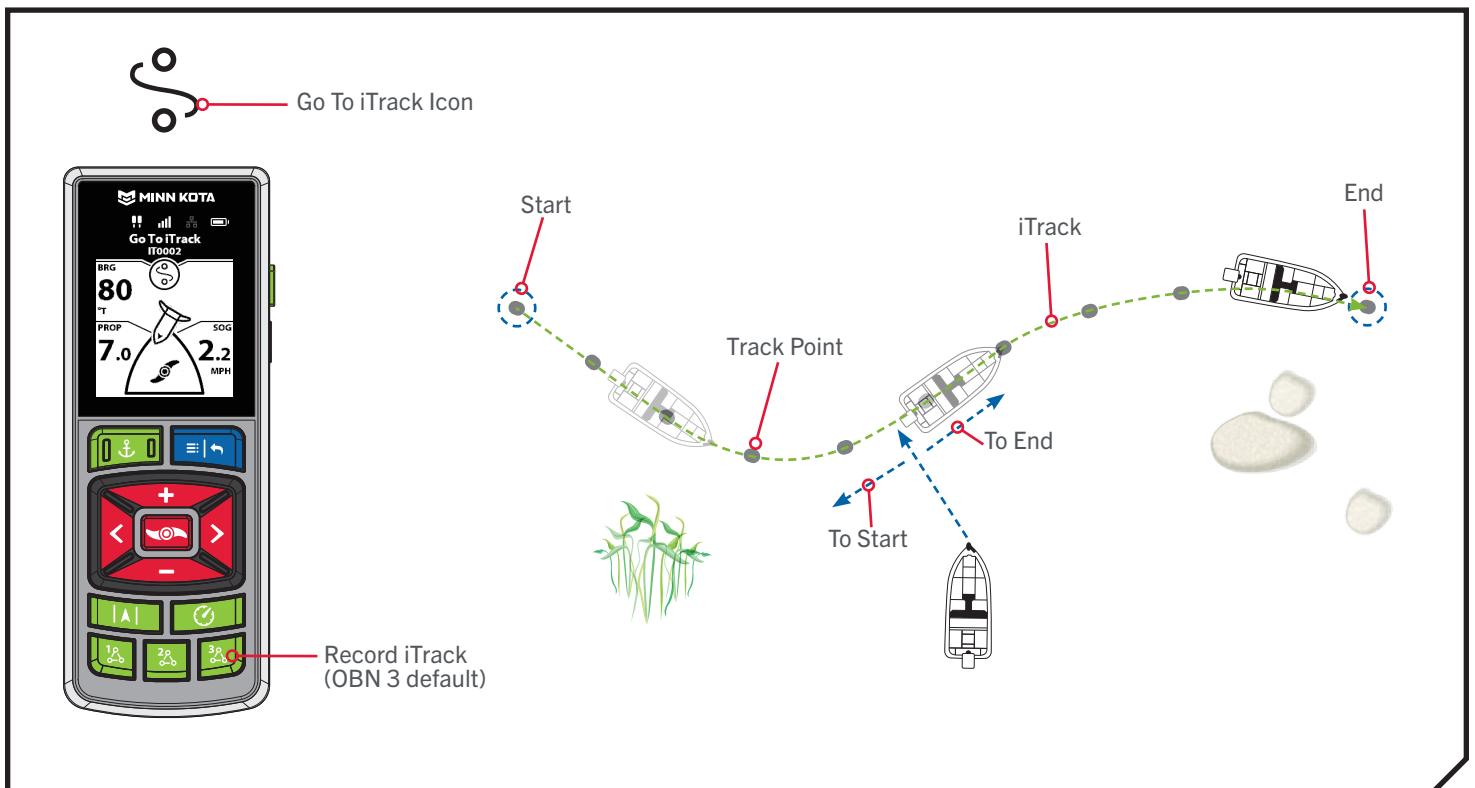



iTRACKS

WORKING WITH iTRACKS >

> Recording an iTrack Using the OBN Button



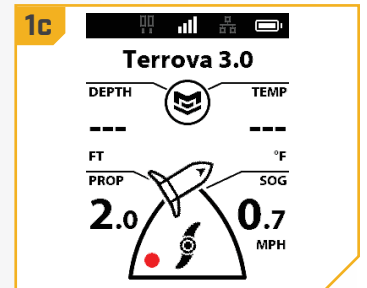
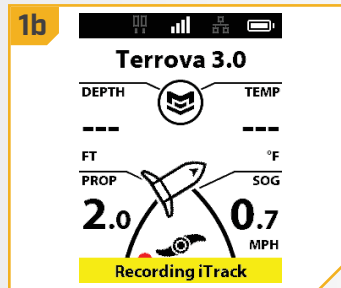

Recording an iTrack is the default OBN 3 button. If the default is changed, it needs to be reprogrammed to access this feature. See the "One-Boat Network" section of this manual to learn more.

- 1 a. Press the OBN 3  button.
- b. A banner will appear at the bottom of the screen for three seconds that displays "Recording iTrack."
- c. The Record  icon will appear on the Dashboard.

NOTICE: Up to 20 iTracks can be recorded to the Wireless Remote. Once full, the remote will display a Storage Full error screen. See the "My Data" section in this manual for instructions on how to delete data to free up space on the remote. Additional iTrack recordings can be saved to the fish finder.



NOTICE: The motor can be stowed while recording an iTrack.

- 2 d. Engage the Prop and manually navigate the desired course.
- e. To Save the recording, press the OBN 3  button again.
- f. The Save iTrack Screen will appear. Use the Speed Up  or Speed Down  button to select Save or Cancel. Make the selection by pressing the Steer Right  button.
- g. A banner will appear at the bottom of the screen for three seconds that displays iTrack Saved.



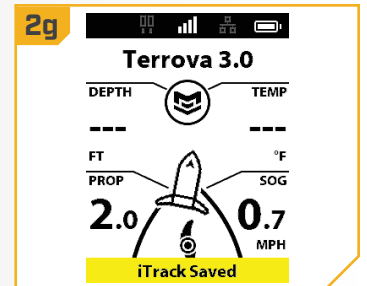





NOTICE: When in AutoPilot while recording an iTrack and Spot-Lock is engaged, iTrack recording will be paused. Once the Spot-Lock feature is disengaged, iTrack recording will be resumed. If in manual steering, engaging Spot-Lock will stop recording and save the iTrack.



NOTICE: AutoPilot and/or Cruise Control can be used while recording an iTrack.

› Recording an iTrack Using the Menu Button

1



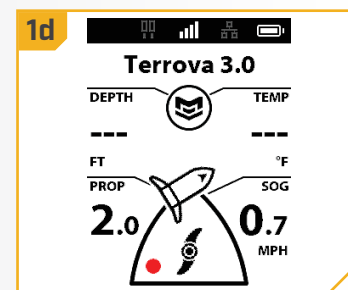
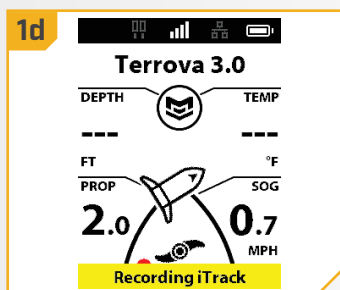
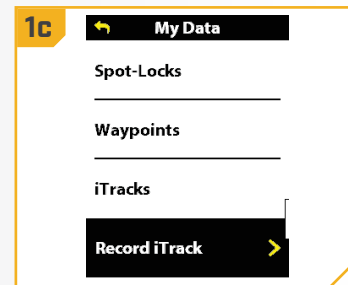
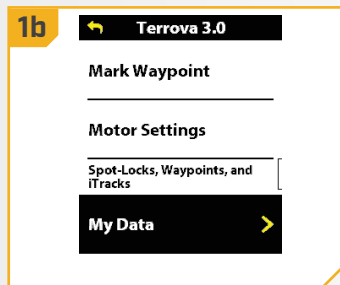



- a. Press the Menu  button.
- b. Use the Speed Up  or Speed Down  button to find My Data, and select it by pressing the Steer Right  button.
- c. In the My Data Menu, use the Speed Up  or Speed Down  button to find Record iTrack. Press the Steer Right  button to select it.
- d. The Record  icon will appear on the Dashboard.



NOTICE: Up to 20 iTracks can be recorded to the Wireless Remote. Once full, the remote will display a Storage Full error screen. See the "My Data" section in this manual for instructions on how to delete data to free up space on the remote. Additional iTrack recordings can be saved to the fish finder.

NOTICE: The motor can be stowed while recording an iTrack.

2

- e. Engage the Prop and manually navigate the desired course.
- f. To Save or Stop the recording, press the Menu  button.
- g. Use the Speed Up  or Speed Down  button to find Stop iTrack, and select it by pressing the Steer Right  button.
- h. The Save iTrack Screen will appear. Use the Speed Up  or Speed Down  button to select Save or Cancel, and make the selection by pressing the Steer Right  button.
- i. A banner will appear at the bottom of the screen for three seconds that displays iTrack Saved.

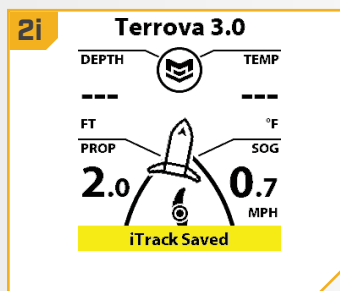
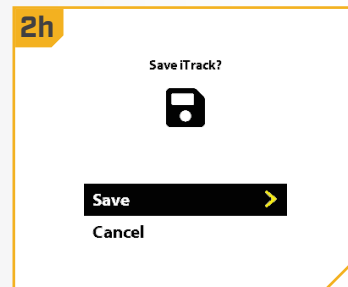
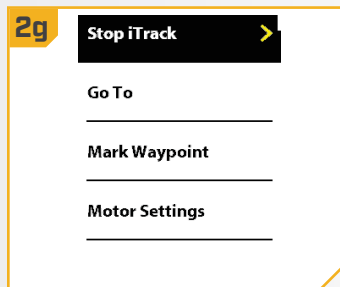





NOTICE: Spot-Lock can be engaged while recording an iTrack. If Spot-Lock is engaged, the iTrack recording will be paused. Once the Spot-Lock feature is disengaged, the iTrack recording will resume.

NOTICE: AutoPilot and/or Cruise Control can be used while recording an iTrack.

› Go To a Saved iTrack Using the OBN Button

Go To is the default for the OBN 2 button. If the default is changed, please see the "One-Boat Network" section of this manual to reprogram the button if desired.





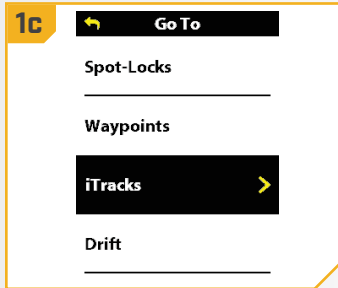

- 1 a. Manually navigate the boat to within a quarter mile of the saved iTrack.
- b. Press the OBN 2  button.
- c. Use the Speed Up  or Speed Down  button to find iTracks, and select it by pressing the Steer Right  button.

NOTICE: Go To is the default function for the OBN 2  button. See the "One-Boat Network" section of this manual for more information on customizing the programmable buttons.



WARNING

Due to safety reasons, the system will not re-engage a saved iTrack greater than a quarter mile away.



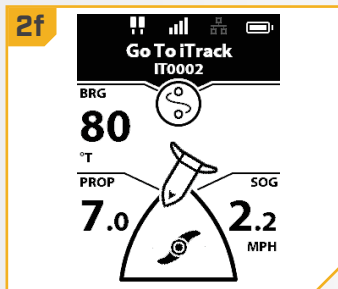
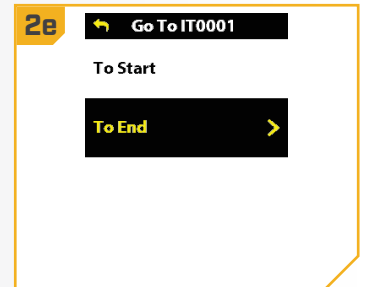
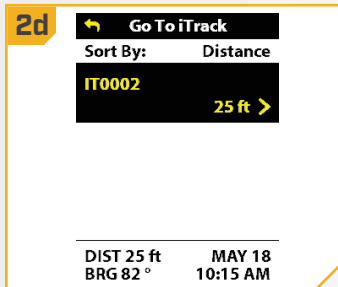

- 2 d. A list of iTracks that are within a quarter mile will appear. Use the Speed Down  and Speed Up  buttons to scroll through the list of iTracks to find an iTrack to navigate to and select it by pressing the Steer Right  button.
- e. Use the Speed Down  and Speed Up  buttons to determine to navigate To Start or To End and select a choice by pressing the Steer Right  button.
- f. The iTrack Active Band will appear in the Dashboard and the boat will start to navigate the selected course.

NOTICE: If Auto Prop On is turned "off," the prop must be enabled before the boat will begin navigating an iTrack.



Go To a Saved iTrack Using the Menu Button

1



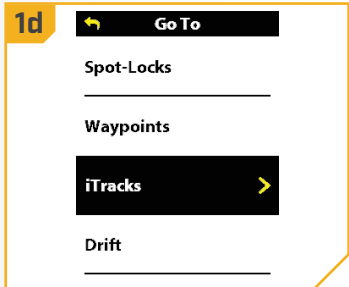
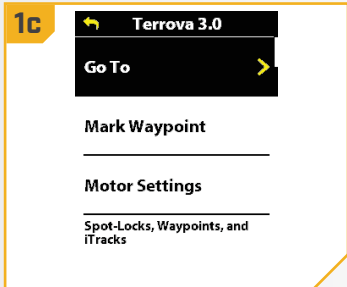



- a. Manually navigate the boat to within a quarter mile of the saved iTrack.
- b. Press the Menu  button.
- c. Select the Go To menu by pressing the Steer Right  button.
- d. Use the Speed Up  or Speed Down  button to find iTracks, and select it by pressing the Steer Right  button.



WARNING

Due to safety reasons, the system will not re-engage a saved iTrack greater than a quarter mile away.

2

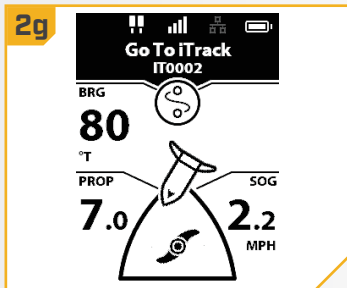
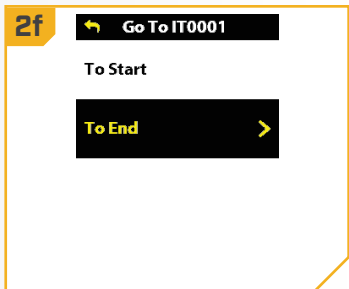
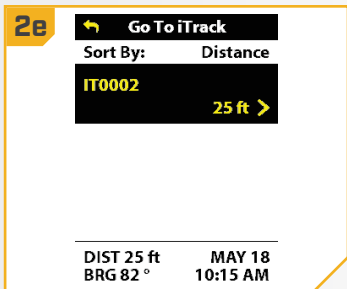

- e. A list of iTracks that are within a quarter mile will appear. Use the Speed Down  and Speed Up  buttons to scroll through the list of iTracks to find an iTrack to navigate to and select it by pressing the Steer Right  button.
- f. Use the Speed Down  and Speed Up  buttons to determine to navigate To Start or To End and select your choice by pressing the Steer Right  button.
- g. The iTrack Active Band will appear in the Dashboard and the boat will start to navigate the selected course.



NOTICE: If Auto Prop On is turned "off," the prop must be enabled before the boat will begin navigating an iTrack.

› Disengage Go To iTrack



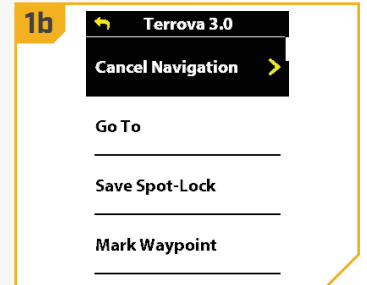
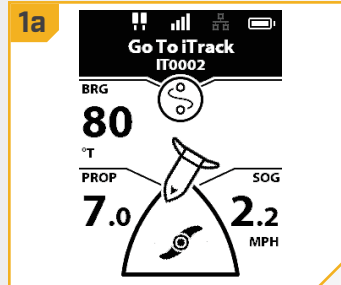

1

- a. When Go To iTrack is engaged, press the Menu  button.
- b. Select Cancel Navigation by pressing the Steer Right  button.
- c. The Go To iTrack Active Band will disappear from the Dashboard.



› Reverse Go To iTrack

1

- a. When Go To iTrack is engaged, press the Menu  button.
- b. Use the Speed Up  or Speed Down  button to scroll to Reverse Navigation, and select it by pressing the Steer Right  button.



CIRCLE MODE

UNDERSTANDING CIRCLE MODE

Circle Mode uses a compatible Humminbird fish finder to set a point to navigate around. Once a point is set, the boat can navigate either clockwise or counterclockwise around the set point in a circle. The radius of the circle can be set between 30 to 500 feet. Circle Mode cannot be activated from the Wireless Remote, but the direction of travel, radius of the circle can be adjusted, and the function can be disengaged using the remote. See the Humminbird manual to learn more about Circle Mode.

NOTICE: Circle Mode is an Advanced GPS navigation feature that can only be initiated from the Humminbird.

⚠ WARNING

Watch for a turning Prop when working with Circle Mode. Auto Prop On is set to "off" by default. If Auto Prop On is turned "on," the Prop will automatically turn on when Circle Mode is engaged, even if the engagement is accidental. A turning Prop can cause injury. If Auto Prop On is turned "off," the Prop must be enabled before the boat will begin navigating with Circle Mode.

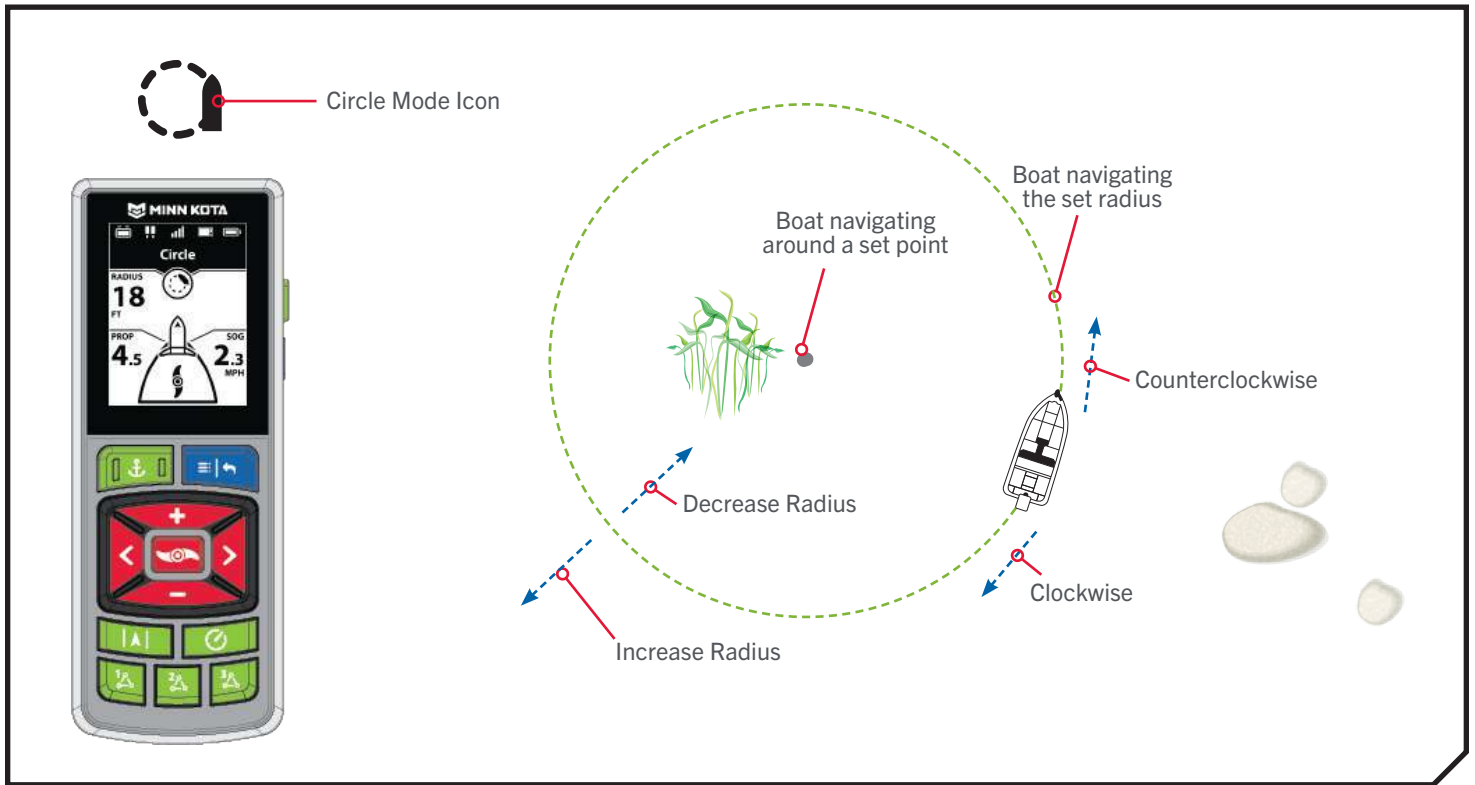







CIRCLE MODE

WORKING WITH CIRCLE MODE >

> Change the Radius of Circle Mode

1



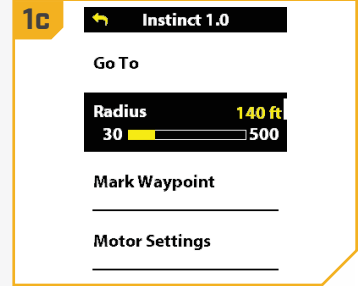

- When Circle Mode is engaged, the Circle Active Band will be displayed on the Dashboard.
- Press the Menu  button.
- Use the Speed Up  or Speed Down  button to find Radius.
- Use the Steer Left  or Steer Right  button to adjust the Radius in five-foot increments.
- Once the desired Radius is found, press and hold the Menu  button to return to the Dashboard.

NOTICE: The radius can be set between 30 to 500 ft. Cruise Control can be used while navigating in Circle Mode.



> Reverse Direction with Circle Mode



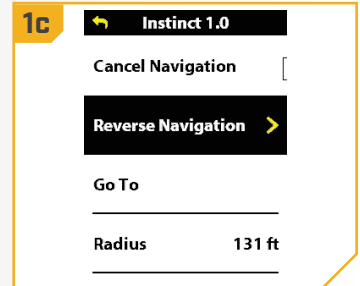
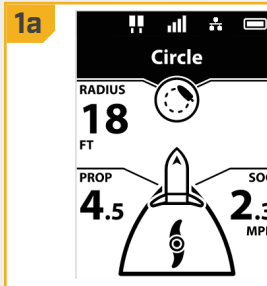

1

- When Circle Mode is engaged, the Circle Active Band will be displayed on the Dashboard.
- Press the Menu  button.
- Use the Speed Up  or Speed Down  button to find Reverse Navigation, and select it by pressing the Steer Right  button.
- The Display Screen will return to the Dashboard and the trolling motor direction will be reversed.



› Disengage Circle Mode

1

- a. When Circle Mode is engaged, the Circle Active Band will be displayed on the Dashboard.
- b. Press the Menu  button.
- c. Use the Speed Up  or Speed Down  button to find Cancel Navigation, and select it by pressing the Steer Right  button.
- d. The Display Screen will return to the Dashboard, and the Circle Active Band will no longer be displayed on the Dashboard.

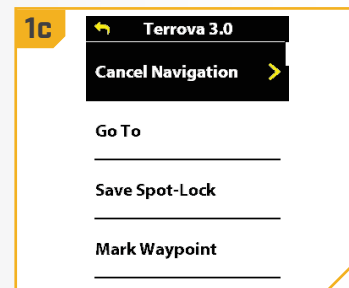
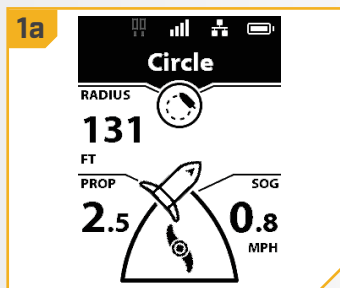

FOLLOW THE CONTOUR

UNDERSTANDING FOLLOW THE CONTOUR

Follow the Contour allows you to navigate a contour on all Humminbird LakeMaster, CoastMaster, and AutoChart ZeroLine charts. When starting Advanced GPS Navigation to Follow the Contour, all other types of navigation are stopped on the fish finder and the Ethernet network. The boat can navigate either clockwise or counterclockwise around the contour. The Offset from the contour can range from -300 to +300 feet. Follow the Contour cannot be activated from the Wireless Remote, but the direction of travel, the contour offset, and disengaging the function can be performed using the Wireless Remote. See the Humminbird manual to learn more about Follow the Contour. If using an AutoChart ZeroLine Map Card, see the AutoChart ZeroLine Map Card Accessory Manual for more information.

NOTICE: Follow the Contour is an Advanced GPS Navigation feature that can only be initiated from the Humminbird fish finder. A compatible Humminbird LakeMaster, CoastMaster or AutoChart SD card is required.

⚠ WARNING

Watch for a turning Prop when working with Follow the Contour. Auto Prop On is set to "off" by default. If Auto Prop On is turned "on," the Prop will automatically turn on when Follow the Contour is engaged, even if the engagement is accidental. A turning Prop can cause injury. If Auto Prop On is turned "off," the Prop must be enabled before the boat will begin navigating with Follow the Contour.

Follow the Contour Icon

Contour Lines

Contour selected from Humminbird to navigate

Offset

Contour can be navigated in both directions.

Contour can be navigated in both directions.

Minn Kota

Follow the Contour

CONTOUR 23 FT

OFFSET 0 FT

PROP 6.0

SOG 1.8 MPH

HUMMINBIRD COASTMASTER U.S. COASTAL VX v1.0

HUMMINBIRD LAKEMASTER FRANCE VX v1.0

HUMMINBIRD LAKEMASTER v2.0 | Pilot

HUMMINBIRD AUTOCHART ZERO LINE MAP CARD v1.0

Humminbird CoastMaster and CoastMaster Premium







Humminbird LakeMaster and LakeMaster Premium with VX technology

Humminbird LakeMaster Legacy

Humminbird AutoChart Zero Line

WORKING WITH FOLLOW THE CONTOUR

Change the Offset with Follow the Contour



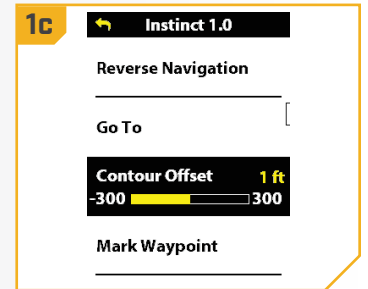
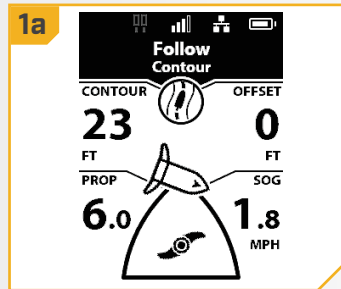

- 1
 - a. When Follow the Contour is engaged, the Follow Active Band will be displayed on the Dashboard.
 - b. Press the Menu  button.
 - c. Use the Speed Up  or Speed Down  button to find Contour Offset, and select it by pressing the Steer Right  button.
 - d. Use the Speed Up  or Speed Down  button to adjust the Contour Offset.
 - e. With the desired offset selected, press and hold the Menu  button to return to the Dashboard.

NOTICE: When setting the Offset, positive numbers will move the boat to navigate to deeper water, and negative numbers will move the boat to shallower water.



NOTICE: Cruise Control can be used while navigating with Follow the Contour.

Reverse Direction with Follow the Contour



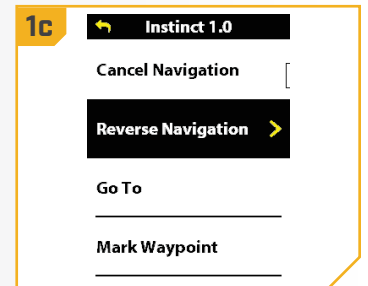
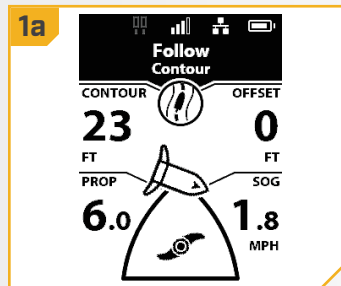

- 1
 - a. When Follow the Contour is engaged, the Follow Active Band will be displayed on the Dashboard.
 - b. Press the Menu  button.
 - c. Use the Speed Up  or Speed Down  button to find Reverse Navigation, and select it by pressing the Steer Right  button.
 - d. The display screen will return to the Dashboard and the trolling motor direction will be reversed.



FOLLOW THE CONTOUR

Disengage Follow the Contour

1

- a. When Follow the Contour is engaged, the Follow Active Band will be displayed on the Dashboard.
- b. Press the Menu  button.
- c. Use the Speed Up  or Speed Down  button to find Cancel Navigation, and select it by pressing the Steer Right  button.
- d. The display screen will return to the Dashboard, and the Follow Active Band will no longer be displayed on the Dashboard.

NOTICE: If Dodge Mode is set to "off," manually steering the motor with the Wireless Remote or Foot Pedal will also disengage Follow the Contour. If Dodge Mode is set to "on," manually steering the motor with the Wireless Remote or Foot Pedal will engage Dodge Mode.

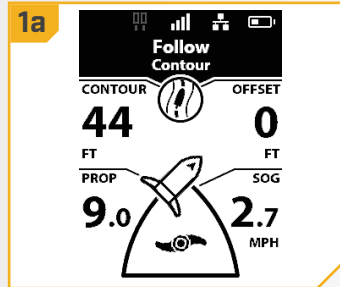

FOLLOW THE SHORELINE

UNDERSTANDING FOLLOW THE SHORELINE

Follow the Shoreline allows you to navigate a shoreline on a Humminbird LakeMaster or CoastMaster SD card with VX technology. When starting Advanced GPS Navigation to Follow the Shoreline, all other types of navigation are stopped on the fish finder and the Ethernet network. The boat can navigate either clockwise or counterclockwise around the shoreline. The Offset from the shoreline can range from 10 to 300 feet. Follow the Shoreline cannot be activated from the Wireless Remote, but the direction of travel, the shoreline offset, and disengaging the function can be performed using the Wireless Remote. See the Humminbird manual to learn more about Follow the Shoreline.

NOTICE: Follow the Shoreline is an Advanced GPS Navigation feature that can only be initiated from the Humminbird fish finder. A compatible Humminbird LakeMaster or CoastMaster card with VX technology is required.

NOTICE: Humminbird CoastMaster, CoastMaster Premium, LakeMaster and LakeMaster Premium SD cards with VX Technology are available to use with HELIX G3/G3N AND G4/G4N fish finders with chartplotting capabilities and all APEX and SOLIX fish finders. Visit humminbird.johnsonoutdoors.com to review the latest compatibility information.

⚠ WARNING

Watch for a turning Prop when working with Follow the Shoreline. Auto Prop On is set to "off" by default. If Auto Prop On is turned "on," the Prop will automatically turn on when Follow the Shoreline is engaged, even if the engagement is accidental. A turning Prop can cause injury. If Auto Prop On is turned "off," the Prop must be enabled before the boat will begin navigating with Follow the Shoreline.

Follow the Shoreline Icon

Contour Lines

Shoreline

Offset

Contour selected from Humminbird to navigate

Contour can be navigated in both directions.

Shoreline

Contour can be navigated in both directions.

Humminbird CoastMaster U.S. COASTAL VX v1.0

Humminbird LakeMaster FRANCE VX v1.0







Humminbird CoastMaster and CoastMaster Premium

Humminbird LakeMaster and LakeMaster Premium with VX technology

FOLLOW THE SHORELINE

WORKING WITH FOLLOW THE SHORELINE >



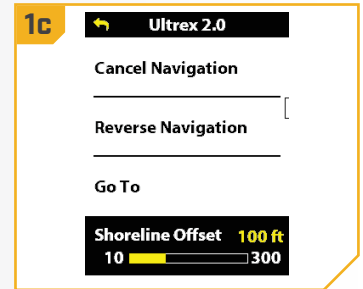
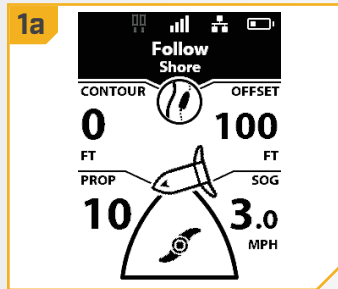

> Change the Offset with Follow the Shoreline

- 1 a. When Follow the Shoreline is engaged, the Follow Active Band will be displayed on the Dashboard.
- b. Press the Menu  button.
- c. Use the Speed Up  or Speed Down  button to find Shoreline Offset, and select it by pressing the Steer Right  button.
- d. Use the Speed Up  or Speed Down  button to adjust the Shoreline Offset.
- e. With the desired offset selected, press and hold the Menu  button to return to the Dashboard.



NOTICE: Cruise Control can be used while navigating with Follow the Shoreline.



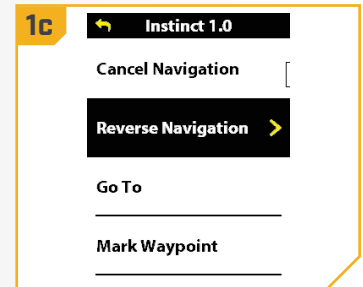
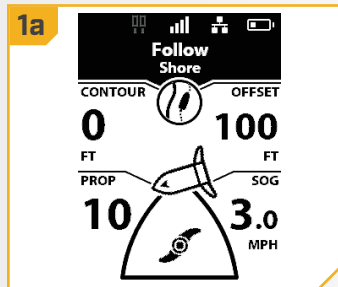

> Reverse Direction with Follow the Shoreline

- 1 a. When Follow the Shoreline is engaged, the Follow Active Band will be displayed on the Dashboard.
- b. Press the Menu  button.
- c. Use the Speed Up  or Speed Down  button to find Reverse Navigation, and select it by pressing the Steer Right  button.
- d. The display screen will return to the Dashboard and the trolling motor direction will be reversed.



› Disengage Follow the Shoreline

1

- a. When Follow the Shoreline is engaged, the Follow Active Band will be displayed on the Dashboard.
- b. Press the Menu  button.
- c. Use the Speed Up  or Speed Down  button to find Cancel Navigation, and select it by pressing the Steer Right  button.
- d. The display screen will return to the Dashboard, and the Follow Active Band will no longer be displayed on the Dashboard.

NOTICE: If Dodge Mode is set to "off," manually steering the motor with the Wireless Remote or Foot Pedal will also disengage Follow the Shoreline. If Dodge Mode is set to "on," manually steering the motor with the Wireless Remote or Foot Pedal will engage Dodge Mode.

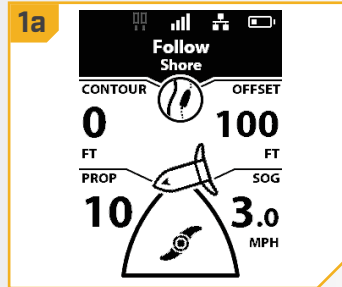

ROUTES

UNDERSTANDING ROUTES

Routes link two or more Waypoints together to create a path for navigation and are used in trip planning. A Route represents the intended navigation and shows the shortest path from each waypoint to the next. Navigating a Route is initiated on the Humminbird. As you travel a Route, staying on the route line is the most efficient way to get to the destination; although, always look out for obstacles not shown on the Humminbird. Navigating a Route cannot be activated from the Wireless Remote, but the direction of travel can be changed, and the function can be disengaged using the remote. If starting another mode of GPS navigation, navigating a Route will disengage automatically. The exception is Spot-Lock. If Spot-Lock is engaged, Route navigation will be paused, not disengaged. See the Humminbird manual to learn more about Routes.

NOTICE: Routes are an Advanced GPS Navigation System feature that can only be initiated from the Humminbird.

⚠ WARNING



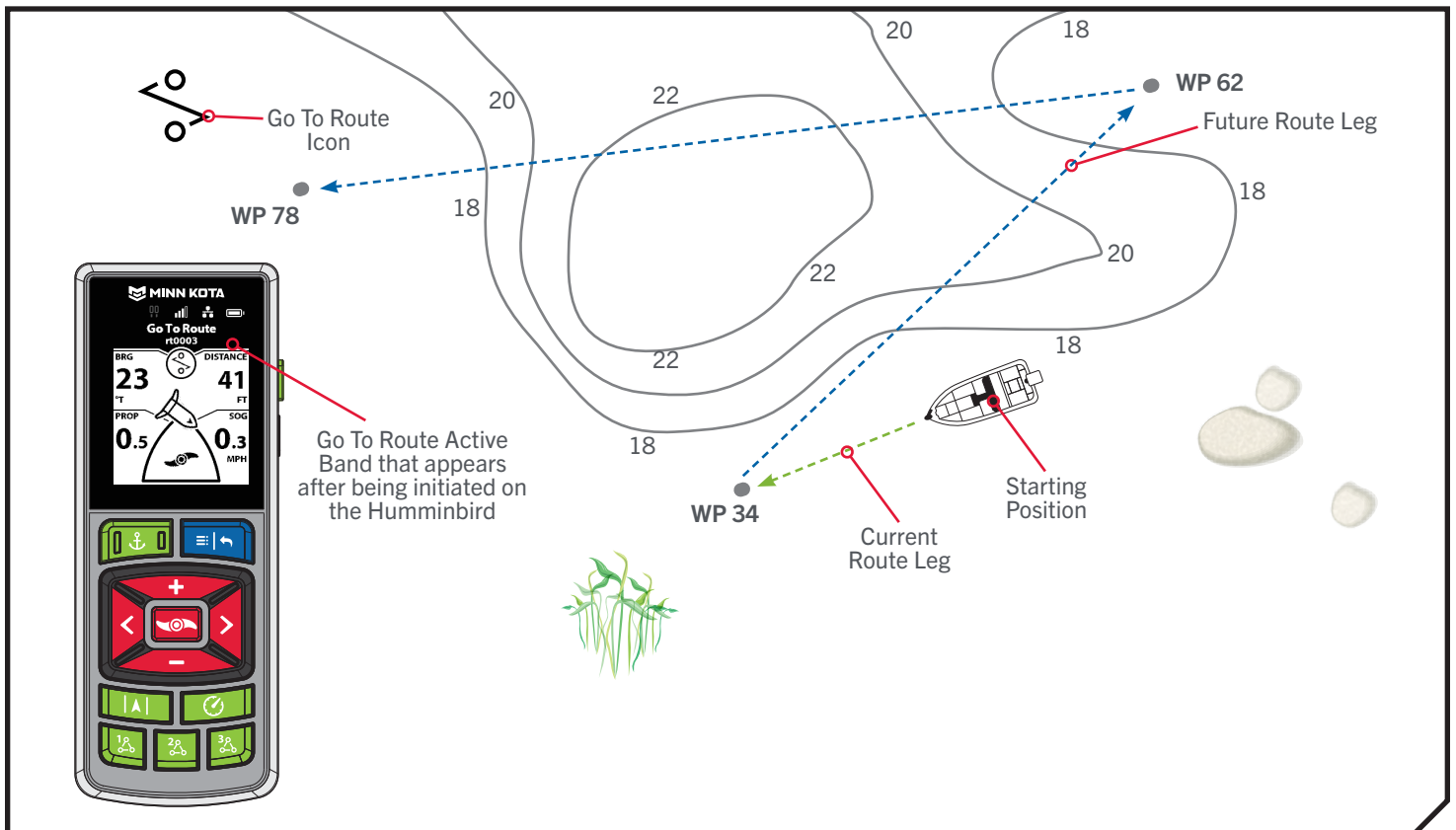

Watch for a turning Prop when working with Routes. Auto Prop On is set to "off" by default. If Auto Prop On is turned "on," the Prop will automatically turn on when Routes are navigated, even if the engagement is accidental. A turning Prop can cause injury. If Auto Prop On is turned "off," the Prop must be enabled before the boat will begin navigating Routes.



WORKING WITH ROUTES >

> Reverse the Direction of Route Navigation

1



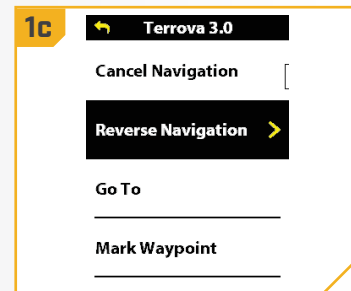
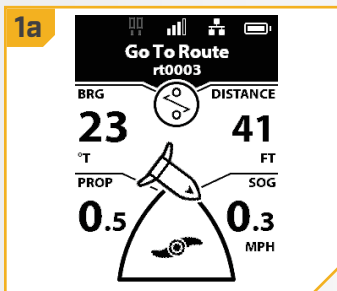

- When Route navigation is engaged, the Go To Route Active Band will be displayed on the Dashboard.
- Press the Menu  button.
- Use the Speed Up  or Speed Down  button to find Reverse Navigation, and select it by pressing the Steer Right  button.
- The display screen will return to the Dashboard and the trolling motor direction will be reversed.

NOTICE: The Humminbird can make Quick Routes or Go To a Route. To learn more about Routes, please see the Humminbird manual.



> Disengage Route Navigation

1

- When Route navigation is engaged, the Go To Route active band will be displayed on the Dashboard.
- Press the Menu  button.
- Use the Speed Up  or Speed Down  button to find Cancel Navigation, and select it by pressing the Steer Right  button.
- The display screen will return to the Dashboard, and the Go To Route Active Band will no longer be displayed on the Dashboard.

NOTICE: If Dodge Mode is set to "off," manually steering the motor with the Wireless Remote or Foot Pedal will also disengage Go To Route. If Dodge Mode is set to "on," manually steering the motor with the Wireless Remote or Foot Pedal will engage Dodge Mode.

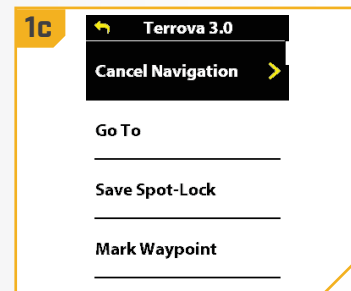
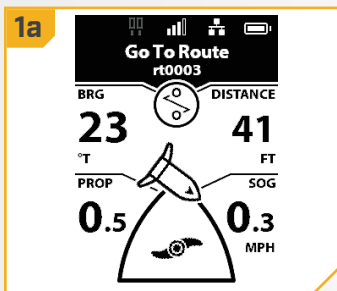







MY DATA

MANAGING NAVIGATION DATA

Use the My Data menu to view saved navigation data, including Spot-Locks, Waypoints, and iTracks. Each data point displays the distance, bearing, and timestamp. Change the order of how the lists of Spot-Locks, Waypoints, and iTracks are displayed; delete navigation data from the remote; and start recording an iTrack from the My Data menu.





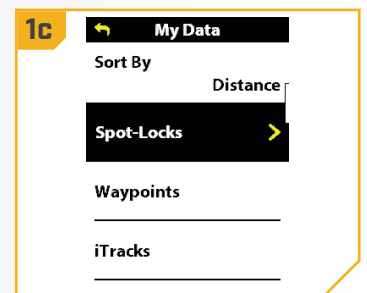
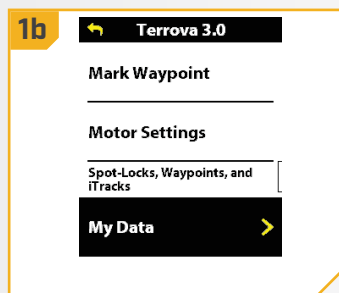

VIEWING NAVIGATION DATA >

> Viewing Spot-Locks





- 1
 - a. Press the Menu  button.
 - b. Use the Speed Up  or Speed Down  button to find My Data, and select it by pressing the Steer Right  button.
 - c. In the My Data Menu, use the Speed Up  or Speed Down  button to find Spot-Locks. Press the Steer Right  button to select it.

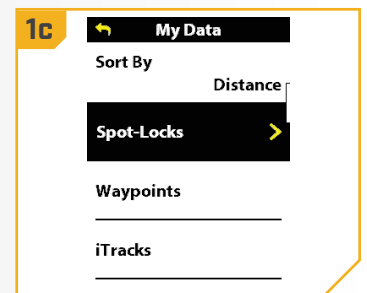
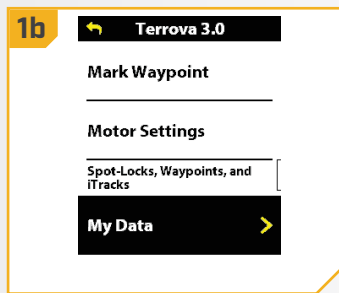

> Deleting a Spot-Lock

- 1
 - a. Press the Menu  button.
 - b. Use the Speed Up  or Speed Down  button to find My Data, and select it by pressing the Steer Right  button.
 - c. In the My Data Menu, use the Speed Up  or Speed Down  button to find Spot-Locks. Press the Steer Right  button to select it.





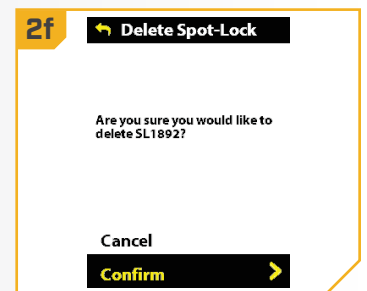
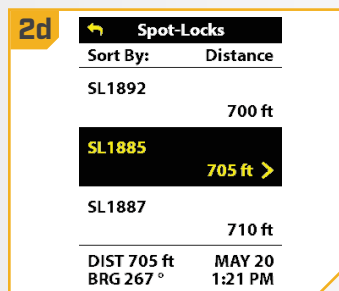



- 2
 - d. Use the Speed Up  or Speed Down  button to scroll through the list of Spot-Locks.
 - e. The bottom banner updates to display the Distance to the Spot-Lock, the Bearing, and the date and timestamp the Spot-Lock was saved.
 - f. To delete the selected Spot-Lock, press the Steer Right  button. Press the Speed Down  button to highlight Confirm, and press the Steer Right  button to select it.



NOTICE: To delete all Spot-Locks, Waypoints, and iTracks at once, see the "Restoring My Data" section of this manual.

› Viewing Waypoints





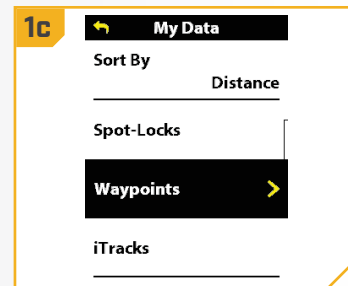
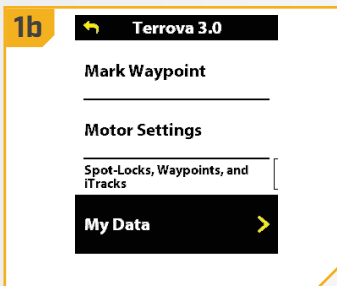

1

- Press the Menu  button.
- Use the Speed Up  or Speed Down  button to find My Data, and select it by pressing the Steer Right  button.
- In the My Data Menu, use the Speed Up  or Speed Down  button to find Waypoints. Press the Steer Right  button to select it.





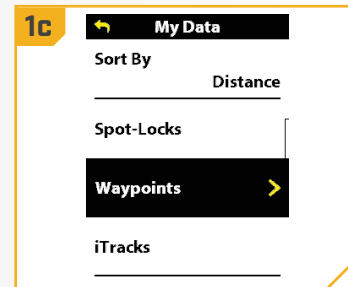
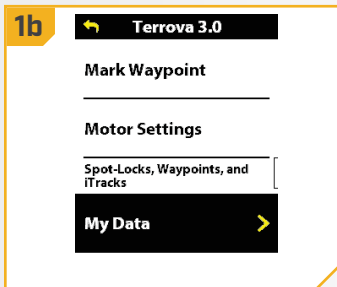

› Deleting a Waypoint

1

- Press the Menu  button.
- Use the Speed Up  or Speed Down  button to find My Data, and select it by pressing the Steer Right  button.
- In the My Data Menu, use the Speed Up  or Speed Down  button to find Waypoints. Press the Steer Right  button to select it.



2

- Use the Speed Up  or Speed Down  button to scroll through the list of Waypoints.
- The bottom banner updates to display the Distance to the Waypoint, the Bearing, and the date and timestamp the Waypoint was saved.
- To delete the selected Waypoint, press the Steer Right  button. Press the Speed Down  button to highlight Confirm, and press the Steer Right  button to select it.

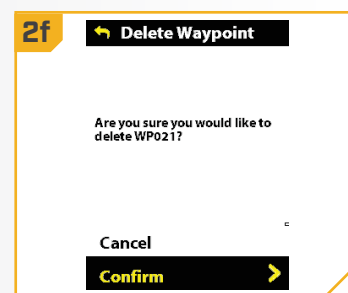
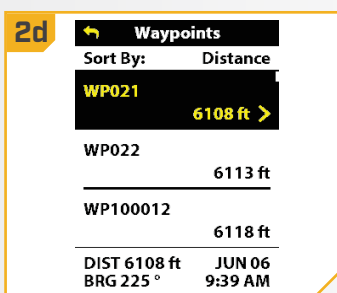







NOTICE: To delete all Spot-Locks, Waypoints and iTracks at once, see the "Restoring My Data" section of this manual.

MY DATA

› Viewing iTracks





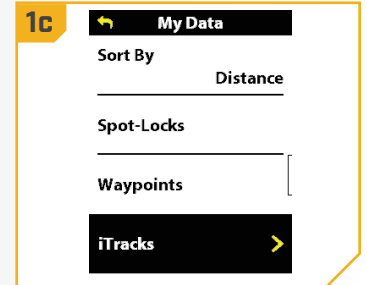
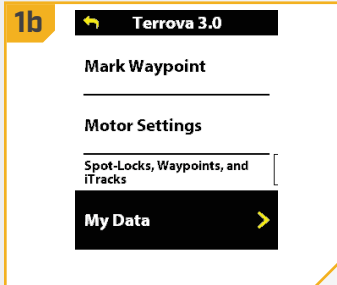

1

- Press the Menu  button.
- Use the Speed Up  or Speed Down  button to find My Data, and select it by pressing the Steer Right  button.
- In the My Data Menu, use the Speed Up  or Speed Down  button to find iTracks. Press the Steer Right  button to select it.





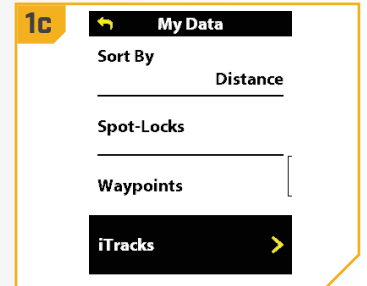
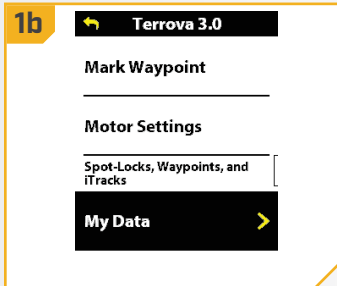

› Deleting an iTrack

1

- Press the Menu  button.
- Use the Speed Up  or Speed Down  button to find My Data, and select it by pressing the Steer Right  button.
- In the My Data Menu, use the Speed Up  or Speed Down  button to find iTracks. Press the Steer Right  button to select it.



2

- Use the Speed Up  or Speed Down  button to scroll through the list of iTracks.
- The bottom banner updates to display the Distance to the iTrack, the Bearing, and the date and timestamp of when the iTrack was saved.
- To delete the selected iTrack, press the Steer Right  button. Press the Speed Down  button to highlight Confirm, and press the Steer Right  button to select it.

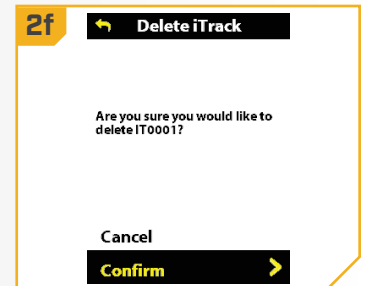
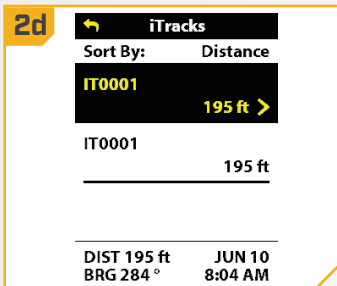







NOTICE: To delete all Spot-Locks, Waypoints, and iTracks at once, see the "Restoring My Data" section of this manual.

› Sorting My Data

The Sort By options include sorting by Distance (closest listed first), Name (alphabetical order) or Time (most recent date created to oldest date).

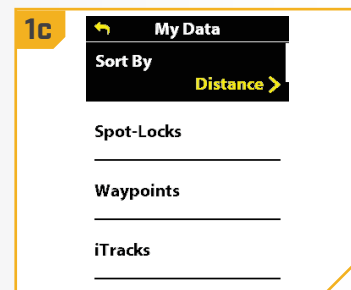
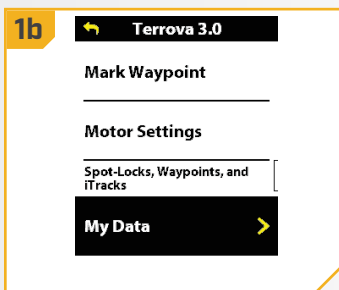

1

- a. Press the Menu  button.
- b. Use the Speed Up  or Speed Down  button to find My Data, and select it by pressing the Steer Right  button.
- c. In the My Data Menu, use the Speed Up  or Speed Down  button to find Sort By. Press the Steer Right  button to select it.



NOTICE: Changing the list sort order organizes how the list of Spot-Locks, Waypoints, and iTracks is displayed.

2

- d. The Sort By options will appear. Options include sorting by Distance (closest listed first), Name (alphabetical order) or Time (most recent date created to oldest date).
- e. Use the Speed Up  or Speed Down  button to scroll through the list of Sort By options.
- f. Press the Steer Right  button to select it. The circle to the right of the selected function will be colored in yellow when selected.

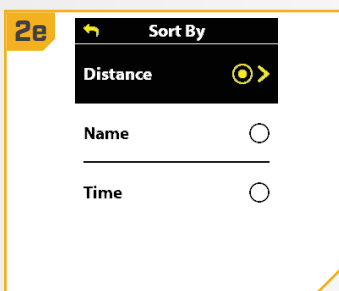





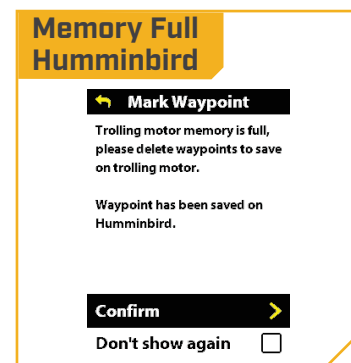
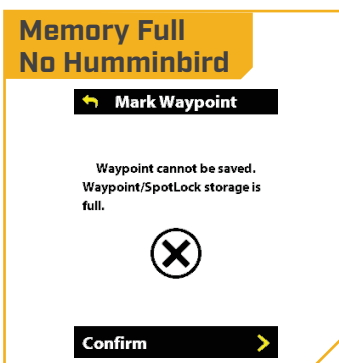

› Memory Full

Up to 20 Spot-Lock or Waypoint locations can be recorded and up to 20 iTracks can be recorded to the trolling motor. If the Advanced GPS Navigation system is not connected to a Humminbird fish finder once the storage is full, the remote will display a Storage Full error screen. If the Advanced GPS Navigation system is connected to a Humminbird fish finder and the storage is full, the remote will display a notification that the data will be saved to the fish finder. To turn the notification "on" or "off," access the Memory Full Message in My Data.



MY DATA

1

- Press the Menu  button.
- Use the Speed Up  or Speed Down  button to find My Data, and select it by pressing the Steer Right  button.
- In the My Data Menu, use the Speed Up  or Speed Down  button to find Memory Full Message. Press the Steer Right  button to select it.

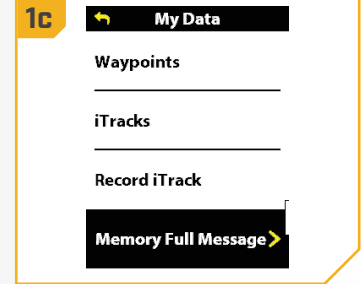
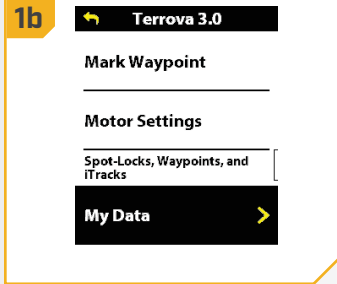

2



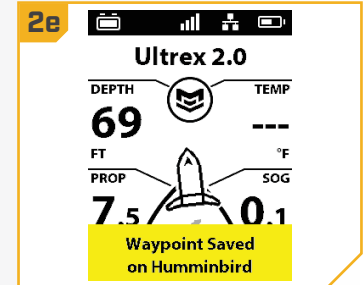
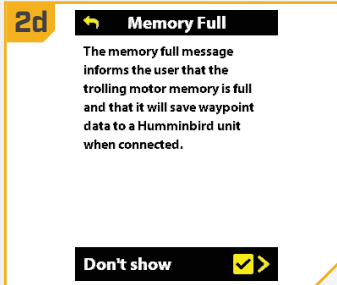



- To turn the Memory Full message "on" or "off," press the Steer Right  button to check or uncheck the setting.
- Regardless of if the Memory Full message is turned "on" or "off," a banner will display on the display screen each time data is saved to the Humminbird.



Restoring My Data



Restore My Data deletes all the saved Spot-Locks, Waypoints, and iTracks that have been stored on the trolling motor.

1

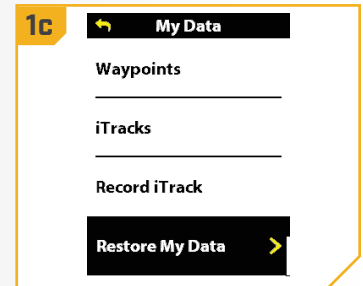
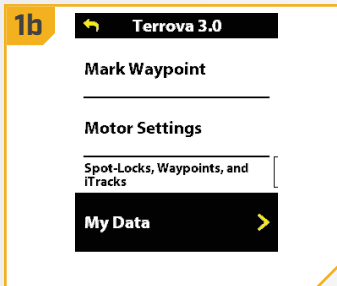
- Press the Menu  button.
- Use the Speed Up  or Speed Down  button to find My Data, and select it by pressing the Steer Right  button.
- In the My Data Menu, use the Speed Up  or Speed Down  button to find Restore My Data. Press the Steer Right  button to select it.



2



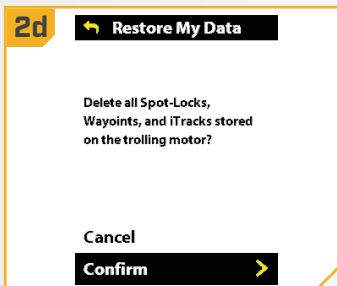



- To delete all Spot-Locks, Waypoints, and iTracks stored on the trolling motor, press the Speed Down  button to highlight Confirm, and press the Steer Right  button to select it.



MOTOR CONTROLS

› To Toggle the Prop Auto On

1

- Press the Menu  button.
- Use the Speed Up  or Speed Down  button to find the Motor Settings menu. Use the Steer Right  button to select Motor Settings.
- In the Motor Settings Menu, use the Speed Up  or Speed Down  button to find Prop Auto On.
- By default, the Prop Auto On is toggled "off."
- Use the Steer Right  button to toggle between "on" and "off."



WARNING

When the Prop Auto On is toggled "on," the Prop will turn on when navigation features are used. Navigation features include working with iTracks and AutoPilot. Be sure that the Prop is clear from obstructions and hazards when using navigation features.

NOTICE: Prop Auto On is not the same as the Prop ON/OFF button. Prop Auto On will affect navigational features. The Prop ON/OFF button refers to the prop status during normal use. The Prop Auto On does not affect the operation of Prop ON/OFF.

1b

← Ultrerra 2.0

Go To

Mark Waypoint

Motor Settings >

Spot-Locks, Waypoints, and iTracks

1c

← Motor Settings

Battery Saver

Max Thrust

One-Boat Network [

Prop Auto On









Off >

NOTICE: Prop Auto On does not affect the Prop when Cruise Control is being used, or when Max Speed is engaged. If Prop Auto On is not working as expected, check the motor speed. The Prop will turn at the current speed setting when Prop Auto On is engaged. If the Prop Auto on feature turns the prop on, and the Prop is not turning, the speed may be set to 0.

MOTOR CONTROLS





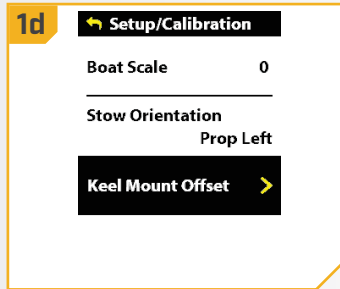
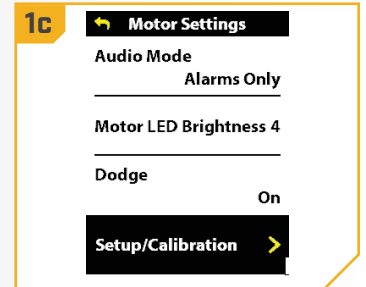
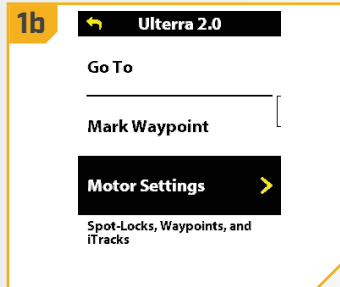

› Setting the Keel Mount Offset ♦

The Keel Mount Offset adjusts the position of the motor in relation to the Keel. This function is only performed on motors with an internal Heading Sensor. For motors with an external Heading Sensor, see "Setting the Heading Sensor Calibration."

- 1 a. Press the Menu  button.
- b. Use the Speed Up  or Speed Down  button to find the Motor Settings menu. Use the Steer Right  button to select Motor Settings.
- c. In the Motor Settings Menu, use the Speed Up  or Speed Down  button to find Setup/Calibration.
- d. In the Setup/Calibration menu, use the Speed Up  or Speed Down  button to find Keel Mount Offset. Use the Steer Right  button to select Keel Mount Offset.

NOTICE: This feature is only available on QUEST series motors.



- 2 e. Review all safety warnings. Use the Steer Right  button to select Start and begin the process.
- f. Use the Steer Left  or Steer Right  button to point the motor forward and parallel to the Keel.
- g. When satisfied with the placement of the trolling motor, use the Speed Up  or Speed Down  button to scroll to Set. Use the Steer Right  button to select Set. The degree of offset is displayed at the bottom of the Dashboard.

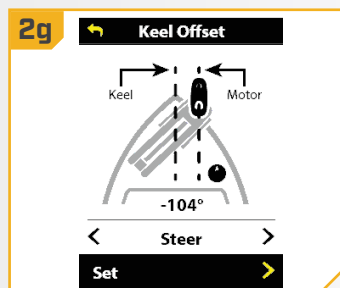
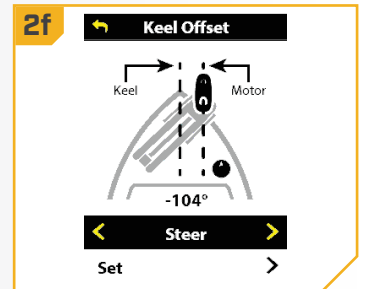
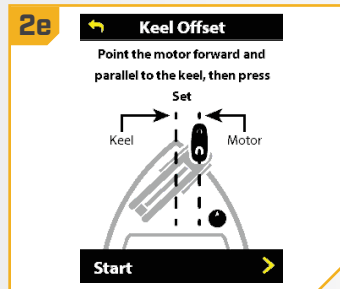







♦ Only available on QUEST series trolling motors.

› To Toggle Straight on Deploy

Minn Kota recommends setting the Keel Offset when the position of the Lower Unit is parallel with the Keel. Save the Keel Offset before exploring the Straight on Deploy feature. Straight on Deploy uses the position recorded in Keel Offset to know where to position the Lower Unit to be parallel with the Keel. When Straight on Deploy is engaged, the trolling motor will deploy the motor and automatically rotate the Lower Unit to the position saved to memory in Keel Offset. By default, the Lower Unit will be parallel to the Keel when the Mount is parallel to the Keel. If the Keel Offset was programmed to another angle, the Straight on Deploy feature will correct the position to match the corrected angle when turned "on." If straight on deploy is turned "off," the trolling motor will not correct the position in any direction.

1



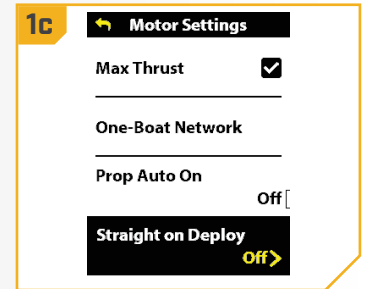
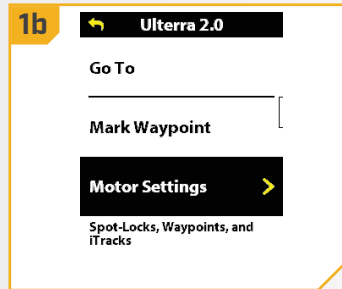



- a. Press the Menu  button.
- b. Use the Speed Up  or Speed Down  button to find the Motor Settings menu. Use the Steer Right  button to select Motor Settings.
- c. In the Motor Settings Menu, use the Speed Up  or Speed Down  button to find Straight on Deploy.
- d. By default, Straight on Deploy is toggled "off."
- e. Use the Steer Right  button to toggle between "on" and "off."



› To Toggle Dodge

When Dodge is turned "on," Dodge Mode is available during Drift Mode, GoTo Spot Lock, GoTo Waypoint, GoTo iTrack, GoTo Route, Circle Mode, Follow the Contour, and Follow the Shoreline.

1

- a. Press the Menu  button.
- b. Use the Speed Up  or Speed Down  button to find the Motor Settings menu. Use the Steer Right  button to select Motor Settings.
- c. In the Motor Settings Menu, use the Speed Up  or Speed Down  button to find Dodge.
- d. By default, Dodge is toggled "on."
- e. Use the Steer Right  button to toggle between "on" and "off."

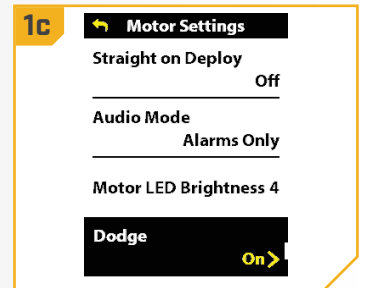
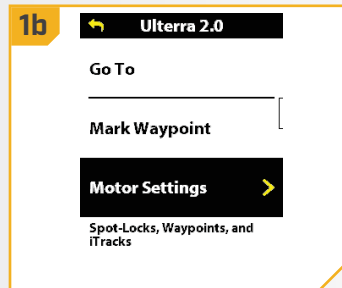







MOTOR CONTROLS

Change the Arrival Mode

The Arrival Mode is a setting that controls what the Advanced GPS Navigation System does once certain navigation modes are complete. Arrival Mode affects Go To functions for iTracks, Waypoints, and Routes. Arrival Mode also affects navigating Routes. The Arrival Mode will take over once the navigational feature has completed. There are four Arrival Modes:

1. Prop Off - Once the boat has completed navigating the iTrack, the Prop will turn off. Prop Off is the default Arrival Mode.
2. Spot-Lock - After the boat has completed navigating the iTrack, the system will go into Spot-Lock at the point where the navigation is completed.
3. AutoPilot - Once the boat has completed navigating the iTrack, it will continue navigating in AutoPilot in the final direction the boat was navigating.
4. Auto Deploy Talon/Raptor - Available as an option only when the Advanced GPS Navigation System is paired with a Talon or Raptor. After the boat has completed navigating, the system will deploy the shallow water anchor. If the system is paired with two shallow water anchors, the action to Auto Deploy Talon/Raptor will control both shallow water anchors.

1

- a. Press the Menu  button.
- b. Use the Speed Up  or Speed Down  button to find the Motor Settings menu. Use the Steer Right  button to select Motor Settings.
- c. In the Motor Settings Menu, use the Speed Up  or Speed Down  button to find Arrival Mode.

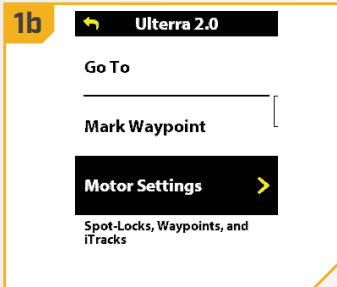

1b

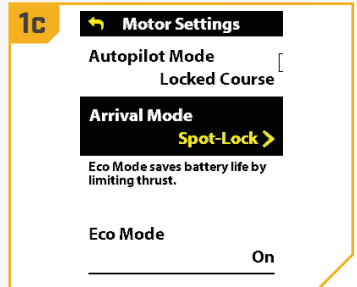

1c



2

- d. Use the Speed Up  or Speed Down  button to find "Prop Off," "Spot-Lock," "Autopilot," or "Auto Deploy Talon/Raptor."
- e. Use the Steer Right  button to make a selection.

NOTICE: By default, the Arrival Mode is set to "Prop Off."



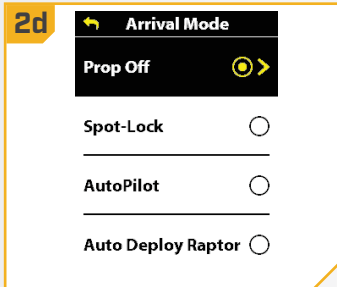





2d



› To Toggle Eco Mode ◆

Eco Mode saves battery life by limiting thrust. It is only available on QUEST series trolling motors.

1

- a. Press the Menu  button.
- b. Use the Speed Up  or Speed Down  button to find the Motor Settings menu. Use the Steer Right  button to select Motor Settings.
- c. In the Motor Settings Menu, use the Speed Up  or Speed Down  button to find Eco Mode. Use the Steer Right  button to select it.
- d. Use the Steer Right  button to toggle between "on" and "off."
- e. A banner will display for three seconds to show that Eco Mode has been turned "on" or "off."

NOTICE: By default, the Eco Mode is set to "off."

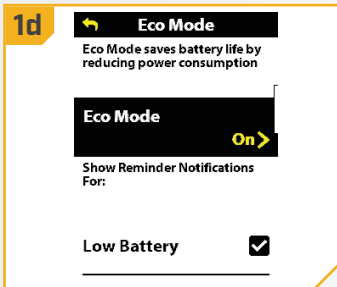
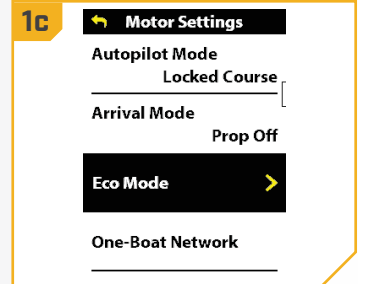
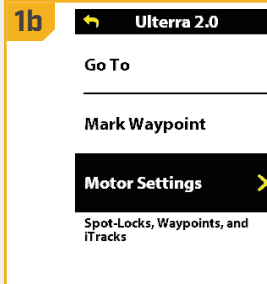









MOTOR CONTROLS

› To Turn on Battery Notifications ♦

Eco Mode provides two battery notifications: Low Battery and Full Battery. These notifications can be turned "on" or "off" in Motor Settings. The Low Battery notification states: "Your battery is below 20%. Would you like to turn Eco Mode on?" This notification is "on" by default. The Full Battery notification states: "Your battery is above 80%. Would you like to turn Eco Mode off?" This notification is turned "off" by default.





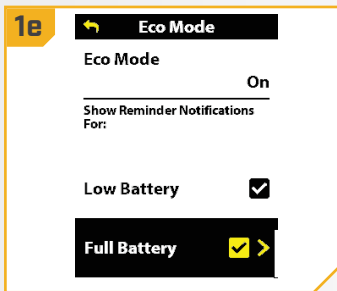
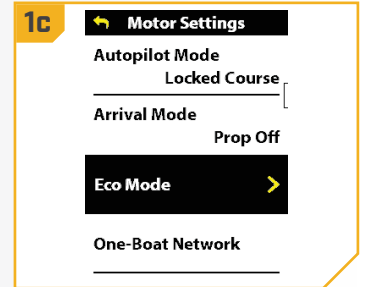
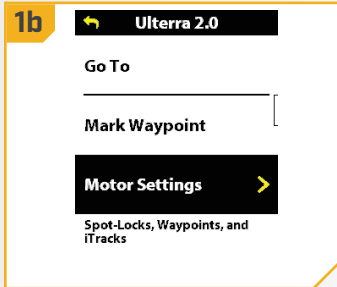



1

- Press the Menu  button.
- Use the Speed Up  or Speed Down  button to find the Motor Settings menu. Use the Steer Right  button to select Motor Settings.
- In the Motor Settings Menu, use the Speed Up  or Speed Down  button to find Eco Mode. Use the Steer Right  button to select it.
- Use the Speed Down  button to highlight either Low Battery or Full Battery.
- Use the Steer Right  button to toggle the notification "on" or "off."



› To Adjust Motor LED Brightness ♦

1

- Press the Menu  button.
- Use the Speed Up  or Speed Down  button to find the Motor Settings menu. Use the Steer Right  button to select Motor Settings.
- In the Motor Settings Menu, use the Speed Up  or Speed Down  button to find Motor LED Brightness.
- Use the Steer Left  or Steer Right  button to adjust the brightness between one (dim) and four (bright).

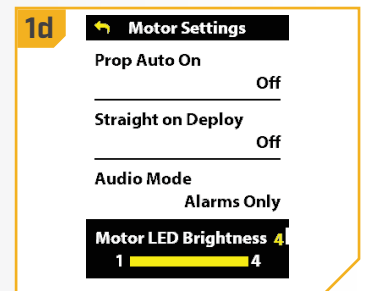
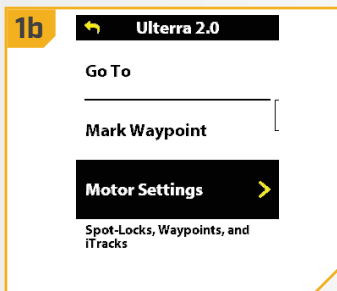

♦ Only available on QUEST series trolling motors.







Adjusting Boat Scale

Trolling motor performance can be impacted by factors including, but not limited to, wind, water conditions, boat specifications, battery health, wiring, etc.





Boat Scale provides a method of adjusting how the trolling motor will perform to account for these and other variables. The Minn Kota trolling motor comes from the factory with Boat Scale set to zero. Boat Scale can be adjusted up (+2) or down (-2) to increase or decrease how the motor control software applies power while using a navigation mode like Spot-Lock.

An example showing the need to reduce Boat Scale would be while using Spot-Lock and the motor is over-correcting or making frequent adjustments. In this case, try reducing Boat Scale to -1 to reduce this behavior. If the behavior continues, reduce Boat Scale to -2.

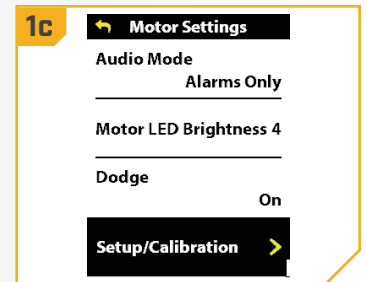
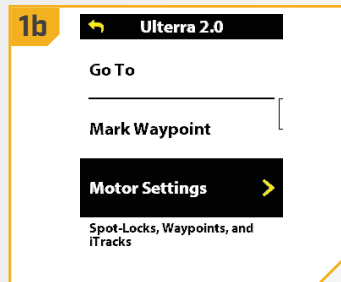
An example showing the need to increase Boat Scale while using Spot-Lock would be the motor is drifting away from its target location frequently or needs help to make corrections. Try increasing Boat Scale to +1 to help improve the trolling motor accuracy in this case. If the behavior continues, increase Boat Scale to +2.





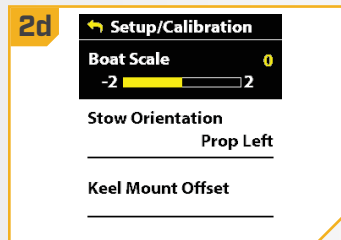

- 1**
 - a. Press the Menu  button.
 - b. Use the Speed Up  or Speed Down  button to find the Motor Settings menu. Use the Steer Right  button to select Motor Settings.
 - c. In the Motor Settings Menu, use the Speed Up  or Speed Down  button to find Setup/Calibration.



- 2**
 - d. Once in the Setup/Calibration menu, use the Speed Up  or Speed Down  button to find Boat Scale.
 - e. Use the Steer Left  or Steer Right  button to adjust the Boat Scale to one of the five settings: -2, -1, 0, 1, or 2.



Setting the Stow Orientation



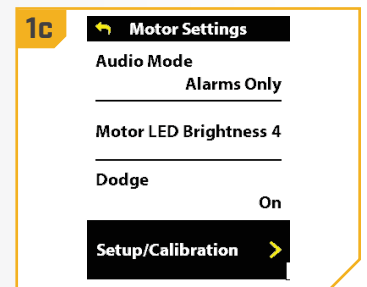
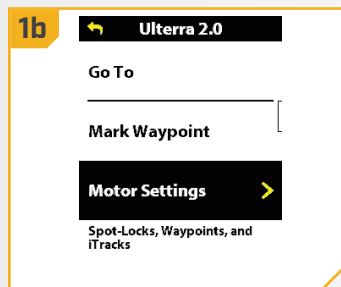



- 1**
 - a. Press the Menu  button.
 - b. Use the Speed Up  or Speed Down  button to find the Motor Settings menu. Use the Steer Right  button to select Motor Settings.
 - c. In the Motor Settings Menu, use the Speed Up  or Speed Down  button to find Setup/Calibration. Use the Steer Right  button to select Setup/Calibration.



■ Only available on select trolling motors.

MOTOR CONTROLS

2



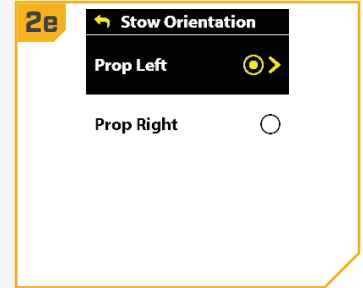
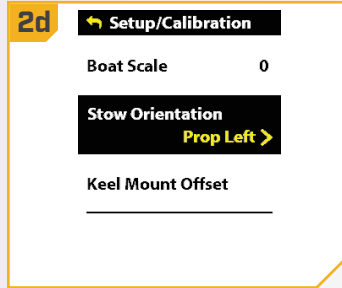





- d. Once in the Setup/Calibration menu, use the Speed Up  or Speed Down  button to find Stow Orientation. Use the Steer Right  button to select Stow Orientation.
- e. Use the Speed Up  or Speed Down  button to select either the Prop Left and Prop Right radial button. Use the Steer Right  button to make the selection.



Setting the Heading Sensor Calibration [^]

This function is only performed on motors with an external Heading Sensor. For motors with an internal Heading Sensor, see "Setting the Keel Mount Offset." For external Heading Sensors, after the Heading Sensor is calibrated, complete "Setting the Heading Offset."

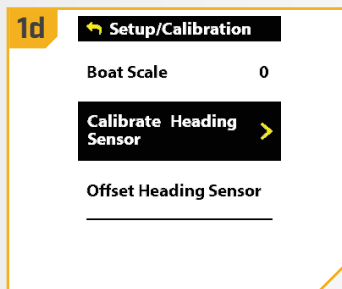
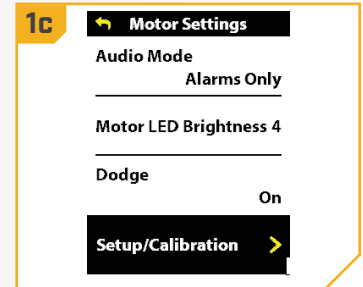
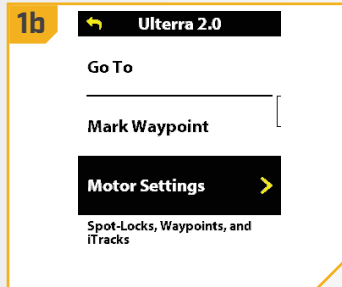

1

- a. Press the Menu  button.
- b. Use the Speed Up  or Speed Down  button to find the Motor Settings menu. Use the Steer Right  button to select Motor Settings.
- c. In the Motor Settings Menu, use the Speed Up  or Speed Down  button to find Setup/Calibration.
- d. In the Setup/Calibration menu, use the Speed Up  or Speed Down  button to find Calibrate Heading Sensor. Use the Steer Right  button to select Calibrate Heading Sensor.



[^] Only available on trolling motors with an external Heading Sensor.

2



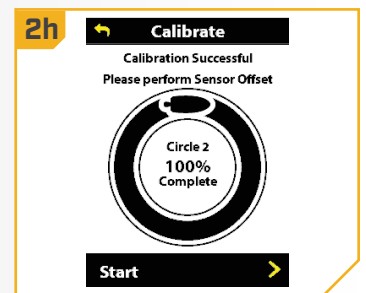
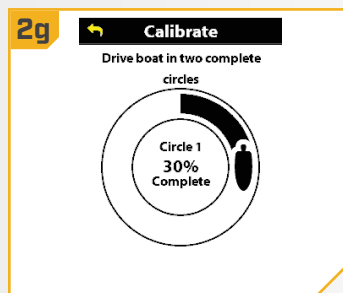
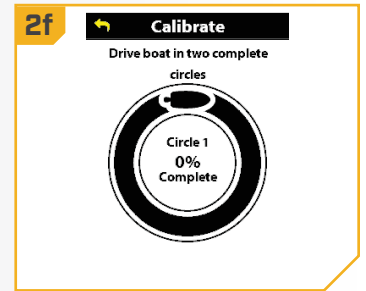
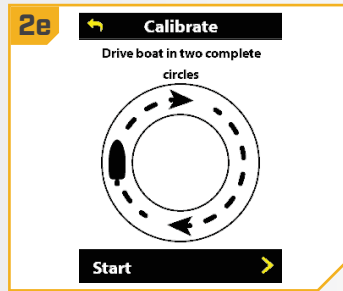





- e. Review all safety warnings. Use the Steer Right  button to select Start and begin the process.
- f. Drive the boat in two complete circles. The center of the Dashboard contains a counter that displays the progress.
- g. The progress of the boat around the circular path will display as a percentage completed for each circle while the boat navigates.
- h. Once the two circles are complete, the Dashboard will briefly read "Calibration Successful. Please perform Sensor Offset."
- i. The Dashboard will then bring up Sensor Offset. Please perform Sensor Offset. Select Start to complete Sensor Offset, or press and hold the Menu  button to close and return to the home screen.



› Setting the Heading Offset

With the Heading Sensor calibrated for external Heading Sensors, set the Heading Offset. Heading Offset is the difference between the angle of the Keel of the boat and the angle at which the Heading Sensor is mounted to the deck of the boat. During installation, the Heading Sensor was installed to be as parallel to the Keel of the boat as possible. If the boat and Heading Sensor are perfectly parallel and pointing in exactly the same direction, the Offset will be 0° degrees. Knowing that installations are rarely perfect, the Heading Offset can be set on the Wireless Remote to compensate for the difference between the Keel and Heading Sensor.





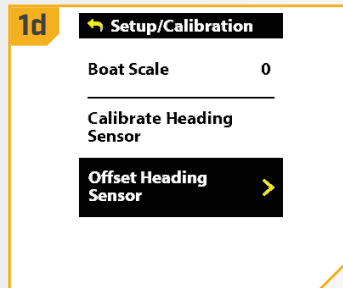
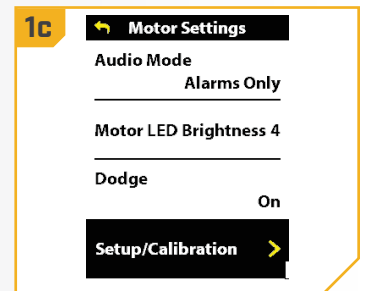
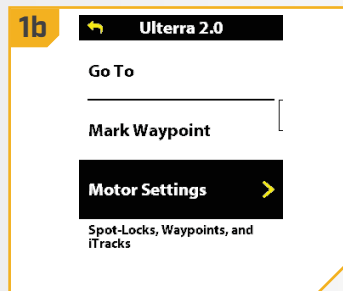

1

- a. Press the Menu  button.
- b. Use the Speed Up  or Speed Down  button to find the Motor Settings menu. Use the Steer Right  button to select Motor Settings.
- c. In the Motor Settings Menu, use the Speed Up  or Speed Down  button to find Setup/Calibration.
- d. In the Setup/Calibration menu, use the Speed Up  or Speed Down  button to find Offset Heading Sensor. Use the Steer Right  button to select Offset Heading Sensor.



MOTOR CONTROLS



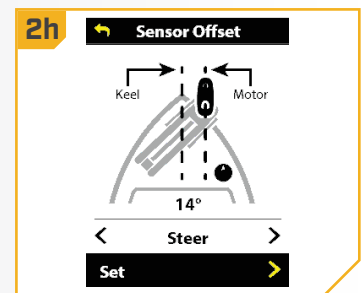
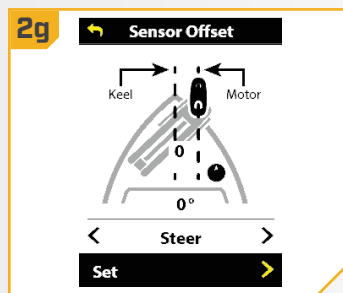
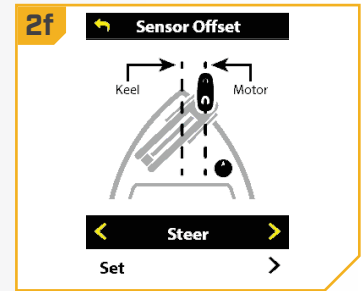
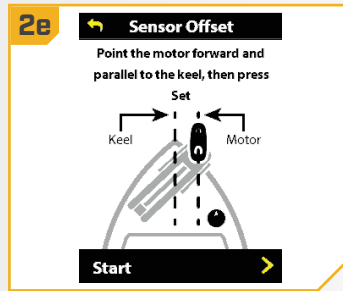

2

- e. Review all safety warnings. Use the Steer Right  button to select Start and begin the process.
- f. Use the Steer Right  or Steer Left  button to point the motor forward and parallel to the Keel.
- g. When satisfied with the placement of the trolling motor, use the Speed Up  or Speed Down  button to scroll to Set. Use the Steer Right  button to select Set. The degree of Sensor Offset is displayed at the bottom of the Dashboard.
- h. Press and hold the Menu  button to close out Sensor Offset and return to the home screen.



Deploying the Motor ●

1

- Press the Power  button.
- Use the Speed Up  or Speed Down  button to find the motor name, either Instinct or Ulterra.
- Press the Steer Right  button to select Instinct or Ulterra.

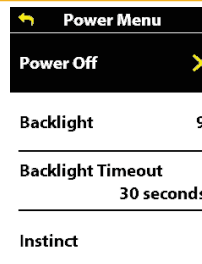

NOTICE: The Instinct/Ulterra menu can only be found in the Power Menu on the Wireless Remote on an Ulterra, Ulterra QUEST, or RT Instinct QUEST.

1a



1c





NOTICE: The default function of the OBN  side button for the Ulterra, Ulterra QUEST, or RT Instinct QUEST is to open the Instinct/Ulterra menu, also called Deployment Mode. Press the OBN  side button to quickly access Deployment Mode. See the "One-Boat Network" section to learn how to program the OBN  side button.

2

- Press the Steer Right  button to select Deploy.

WARNING

As soon as the Deploy button is selected, the motor will automatically deploy. Be sure the motor is clear from obstructions and has a clear path of travel. The Prop is disabled while the motor is being stowed and deployed to prevent accidental contact with the rotating propeller.

- The Instinct/Ulterra motor will deploy. While the Motor is deploying, it is possible to pause the action. To pause the action, press the Steer Right  button to select Pause.
- To resume the Deploy action, press the Steer Right  button to select Deploy.
- If the Motor continues, it will complete the deploy process and normal motor operation will follow.

2d

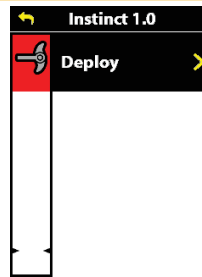

2e

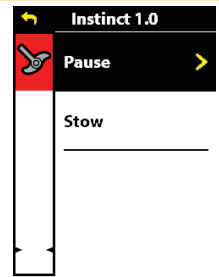

2f

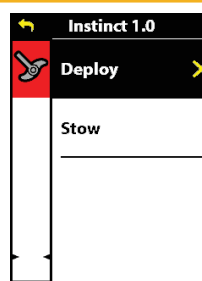







● Only available with Ulterra, Ulterra QUEST & RT Instinct QUEST motors.

MOTOR CONTROLS

› Stowing the Motor ●

1





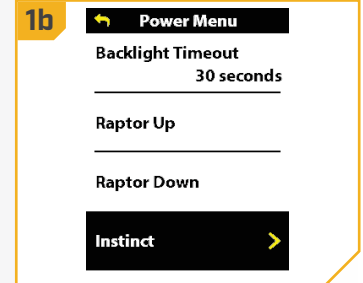
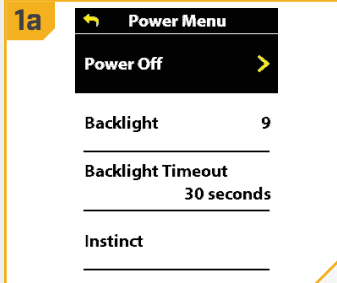

- a. Press the Power  button.
- b. Use the Speed Up  or Speed Down  button to find Instinct. Use the Steer Right  button to select it.

NOTICE: The default function of the OBN  side button for the Ulterra, Ulterra QUEST, or RT Instinct QUEST is to open the Instinct/Ulterra menu, also called Deployment Mode. Press the OBN  side button to quickly access Deployment Mode. See the "One-Boat Network" section to learn how to program the OBN  side button.



NOTICE: The Stow option is only displayed when the motor is deployed.

2

- c. Use the Speed Up  or Speed Down  button to find Stow. Use the Steer Right  button to select it.
- d. The motor will stow. While the Motor is stowing, it is possible to pause the action. To pause the action, press the Speed Down  button to find Pause and press the Steer Right  button to select it.
- e. To resume the Stow action, press the Steer Right  button to select Stow.
- f. If the Motor continues, it will complete the Stow process and normal motor operation will follow.

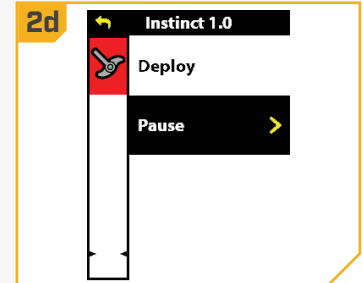
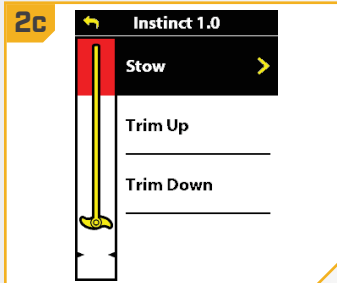

WARNING

As soon as the Stow option is selected, the motor will automatically stow. Be sure the motor is clear from obstructions and has a clear path of travel. The Prop is disabled while the motor is being stowed to prevent accidental contact with the rotating propeller.

● Only available with Ulterra, Ulterra QUEST & RT Instinct QUEST motors.



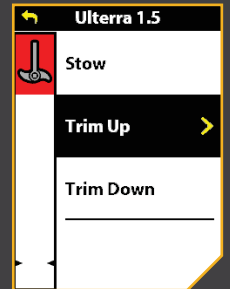

› Adjusting the Trim ●

When trimming the motor using the Wireless Remote, the motor is programmed to operate safely and limit Prop rotation when it is within certain limits. The Prop will temporarily stop while trimming the motor and resume once trimming is stopped. Trim limits are in place to avoid damage to the unit. An upper trim limit is set 12" from the bottom of the mount to the center of the lower unit. A lower trim is set approximately 1.5" from the bottom of the control head to the trim housing. A Prop lockout region, defined as 14" from the bottom of the mount to the center of the lower unit, is used to eliminate the possibility of the motor contacting the boat hull. All functions, with the exception of manual steer and record iTrack, are canceled upon trimming into this region.

NOTICE: The red area is the Prop Lockout region. The Prop will be automatically disabled if the lower unit is trimmed into this zone, and the Prop icon will turn gray. To restore Prop functionality, trim the lower unit out of the Prop Lockout region. The Prop icon will turn yellow when the lower unit is out of the Prop Lockout region.





1

- a. Make sure that the motor is deployed, and then press the Power  button.
- b. Use the Speed Up  or Speed Down  button to find Instinct/Ulterra. Use the Steer Right  button to select it.

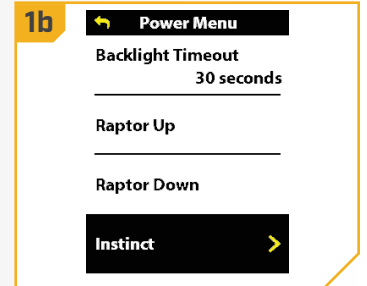
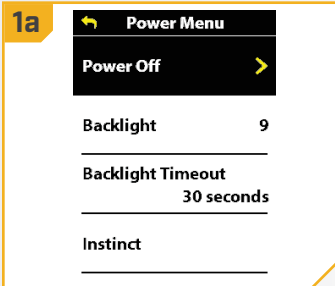
NOTICE: The Trim option is only displayed when the motor is deployed.







NOTICE: The default function of the OBN  side button for the Ulterra, Ulterra QUEST, or RT Instinct QUEST is to open the Instinct/Ulterra menu, also called Deployment Mode. Press the OBN  side button to quickly access Deployment Mode. See the "One-Boat Network" section to learn how to program the OBN  side button.

● Only available with Ulterra, Ulterra QUEST & RT Instinct QUEST motors.

MOTOR CONTROLS

2

- c. Once in the Instinct/Ulterra Menu, use the Speed Up  or Speed Down  button to select Trim Up or Trim Down. Trimming up will raise the motor and trimming down will lower the motor.
- d. Press and hold the Steer Right  button to select it.
- e. When the motor has reached its highest trim limit, the Prop will be locked out and the Trim Up option will be disabled. The Prop will stay locked out even when the Deployment Menu has closed. Trim the motor down and out of the Prop Lockout zone to restore functionality.
- f. When the lower trim limit is reached, the Trim Down option will be disabled.

 **WARNING**

As soon as Trim Up or Trim Down is selected, the motor will automatically trim. Be sure the motor is clear from obstructions and has a clear path of travel. The Prop is disabled while the motor is being trimmed to prevent accidental contact with the rotating Prop.

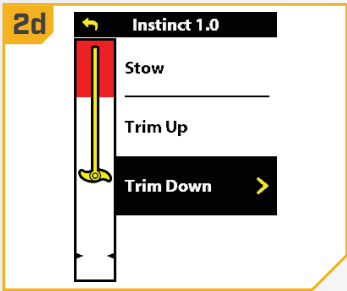
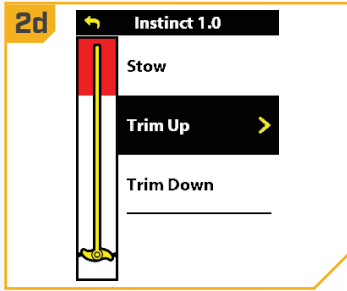
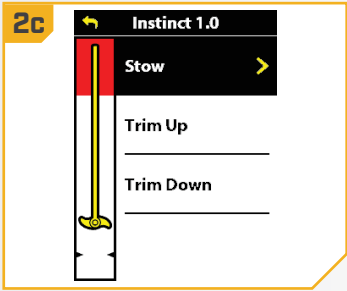



SHALLOW WATER ANCHOR CONTROLS

Minn Kota Shallow Water Anchors can be controlled through the One-Boat Network on the Wireless Remote. When paired to the Advanced GPS Navigation System, a Talon or Raptor can be controlled through the Power Menu on the Wireless Remote or by programming a OBN button. To Pair the Shallow Water Anchor to the Advanced GPS Navigation System, please see the Owner's Manual for the Shallow Water Anchor or the "Service & Maintenance Section" of this manual. Review the control options for either anchor to deploy or retract the anchor with the Wireless Remote. To learn how to program a OBN button to control a SWA, please see the One-Boat Network section of this document.

TALON CONTROL >

> Deploying the Talon(s)

Use the Power Menu on the Wireless Remote to deploy the Talon shallow water anchor. The OBN buttons can also be customized to deploy the Talon.

- 1
 - a. Press the Power  button.
 - b. Use the Speed Up  or Speed Down  button to find Talon Down.

NOTICE: The Talon Down menu option can only be found in the Power Menu on the Wireless Remote paired with a Talon.

- c. Once Talon Down is highlighted, press the Steer Right  button to engage it.
- d. The Talon will deploy. A banner will appear at the bottom of the screen for three seconds that displays Talon Deploying.

NOTICE: The Talon will automatically continue to deploy when the button is pressed until it has reached its full deployment length, received input to stop, or completes anchoring. Do not press and hold the button to keep the Talon deploying.

NOTICE: To deploy the Talon using the OBN button customized for the Talon, double press the assigned OBN button.

NOTICE: When two Talons are paired, the Wireless Remote will engage both Talons. The Wireless Remote cannot specify engaging only either the Port or Starboard Talon. The Talon selected is based on the selection made using the Talon remote.

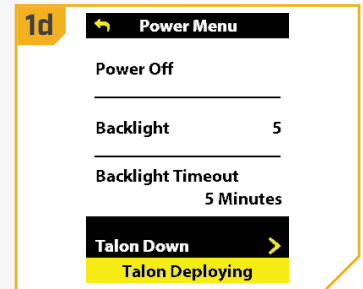
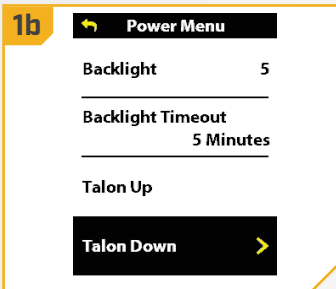

WARNING





Take care that neither you nor other persons approach the Talon too closely while operating, neither with body parts nor with objects. The Talon is powerful and may endanger or injure you or others. While the Talon is operating, watch out for persons swimming and for floating objects. Persons who lack the ability to run the Talon or whose reactions are impaired by alcohol, drugs, medication, or other substances are not permitted to use this product.

CAUTION

The Talon is equipped with a Deployment Notification Alarm. The Alarm is needed to comply with warranty requirements. When properly installed, the alarm will only sound when the ignition key is turned on when the Talon is not fully retracted. Boat control may be affected by a deployed Talon. Take note of the Alarm, and always watch to make sure that the Talon is fully retracted while the boat is operating.

SHALLOW WATER ANCHOR CONTROLS

2

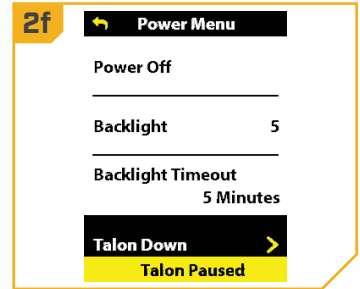
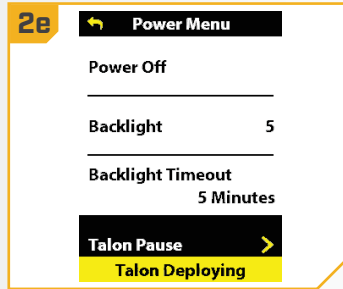

- e. While the Talon is deploying, it is possible to pause the action. To pause the Talon, make sure that Talon Pause is highlighted. Use the Speed Up  or Speed Down  button to highlight Talon Pause.
- f. Press the Steer Right  button to select it. A banner will appear at the bottom of the screen for three seconds that displays Talon Paused.
- g. To resume deploying the Talon, press the Steer Right  button to select Talon Down.
- h. Once the deploying anchor gets to its full length of travel or comes in contact with the bottom, it will go through an anchoring sequence determined by the current anchoring Mode and then stop.



Retracting the Talon(s)

Use the Power Menu on the Wireless Remote to retract the Talon anchor. The OBN buttons can also be customized to retract the Talon.

1

- a. Press the Power  button.
- b. Use the Speed Up  or Speed Down  button to find Talon Up.



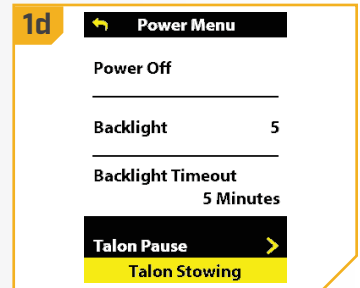
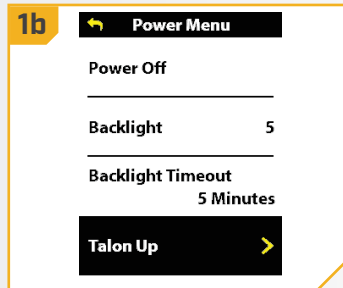

NOTICE: The Talon Up menu option can only be found in the Power Menu on the Wireless Remote paired with a Talon that has been deployed.

- c. Once Talon Up is highlighted, press the Steer Right  button to engage it.
- d. The Talon will stow. A banner will appear at the bottom of the screen for three seconds that displays Talon Stowing.



SHALLOW WATER ANCHOR CONTROLS

2

- e. While the Talon is stowing, it is possible to pause the action. To pause the action, make sure that Talon Pause is highlighted. Use the Speed Up  or Speed Down  button to highlight Talon Pause.
- f. Press Steer Right  button to select it. A banner will appear at the bottom of the screen for three seconds that displays Talon Paused.
- g. To resume stowing the Talon, press Steer Right  button to select Talon Up.
- h. Once the retracting anchor on the Talon gets to its fully retracted state, it will stop.

NOTICE: The Talon will automatically continue to deploy when the button is pressed until it has reached its full deployment length, received input to stop or completes anchoring. Do not press and hold the button to keep the Talon deploying.

NOTICE: When two Talons are paired, the Wireless Remote will engage both Talons. The Wireless Remote cannot specify engaging only either the Port or Starboard Talon. The Talon selected is based on the selection made using the Talon remote.

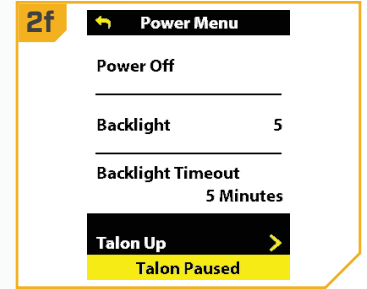
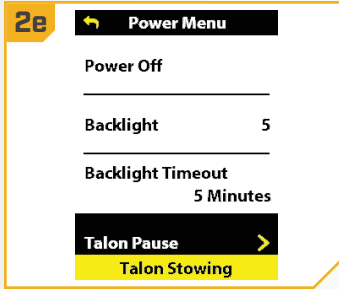

CAUTION

Be sure that the Talon is clear of obstructions and persons while retracting. The spaces between the three stages of the Talons can create a pinch point. Do not come in contact with the Talon while it is retracting to avoid the pinch point.



SHALLOW WATER ANCHOR CONTROLS

RAPTOR CONTROL >



> Deploying the Raptor(s)

Use the Power Menu on the Wireless Remote to deploy the Raptor anchor. The OBN buttons can also be customized to deploy the Raptor shallow water anchor.

1

- a. Press the Power  button.
- b. Use the Speed Up  or Speed Down  button to find Raptor Down.

NOTICE: The Raptor Down menu option can only be found in the Power Menu on the Wireless Remote paired with a Raptor.

- c. Once Raptor Down is highlighted, press the Steer Right  button to engage it. Double press and hold the second press on the Steer Right  button to continually deploy the anchor.
- d. The Raptor will deploy. A banner will appear at the bottom of the screen for three seconds that displays Raptor Deploying.

NOTICE: To deploy the Raptor using a OBN button customized for Raptor, double press the assigned OBN button.

NOTICE: When two Raptors are paired, the Wireless Remote will engage both Raptors. The Wireless Remote cannot specify engaging only either the Port or Starboard Raptor. The Raptor selected is based on the selection made using the Raptor remote.

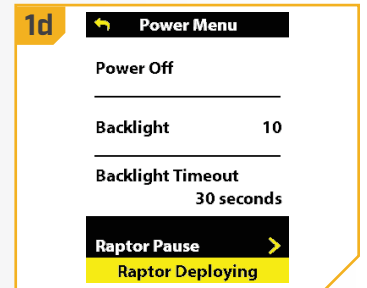
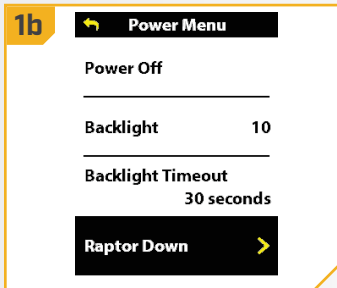

WARNING

Be sure that the Raptor is clear of obstructions and persons while deploying or retracting. Take care that neither you nor other persons approach the Raptor too closely, while operating, neither with body parts nor with objects. The Raptor is powerful and may endanger or injure you or others. While the Raptor is operating, watch out for persons swimming and for floating objects. Persons who lack the ability to run the Raptor or whose reactions are impaired by alcohol, drugs, medication, or other substances are not permitted to use this product.







CAUTION

The spaces between the Outer Arm, Inner Arm, Spike and brackets of the Raptor can create a pinch point. Do not come into contact with an area of the Raptor that may cause a pinch point when it is moving in any direction to avoid risk.

SHALLOW WATER ANCHOR CONTROLS

2

- e. While the Raptor is deploying, it is possible to pause the action. To pause the action, make sure that Raptor Pause is highlighted. Use the Speed Up  or Speed Down  button to highlight Raptor Pause.
- f. Press Steer Right  button to select it. A banner will appear at the bottom of the screen for three seconds that displays Raptor Paused.
- g. To resume deploying the Raptor, press Steer Right  button to select Raptor Down.
- h. Once the deploying anchor gets to its full length of travel or comes in contact with the bottom, it will go through an anchoring sequence determined by the current anchoring Mode and then stop.

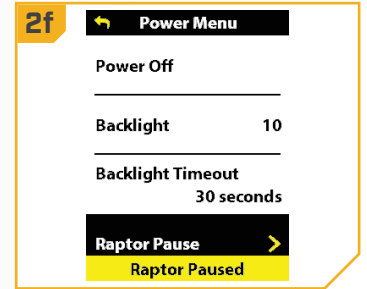
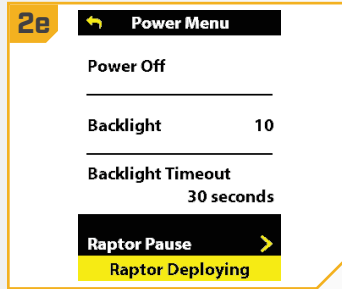



SHALLOW WATER ANCHOR CONTROLS



Retracting the Raptor(s)

Use the Power Menu on the Wireless Remote to retract the Raptor anchor. The OBN buttons can also be customized to retract the Raptor shallow water anchor.

1

- a. Press the Power  button.
- b. Use the Speed Up  or Speed Down  button to find Raptor Up.

NOTICE: The Raptor Up menu option can only be found in the Power Menu on the Wireless Remote paired with a Raptor that has been deployed.

- c. Once Raptor Up is highlighted, press the Steer Right  button to engage it. Double press and hold the second press on the Steer Right  button to continually retract the anchor.
- d. The Raptor will stow. A banner will appear at the bottom of the screen for three seconds that displays Raptor Stowing.

NOTICE: When two Raptors are paired, the Wireless Remote will engage both Raptors. The Wireless Remote cannot specify engaging only either the Port or Starboard Raptor. The Raptor selected is based on the selection made using the Raptor remote.

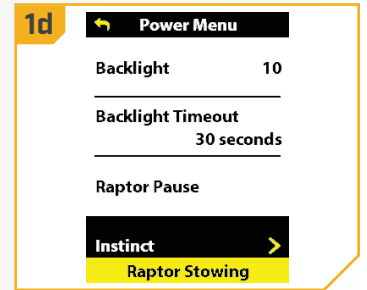
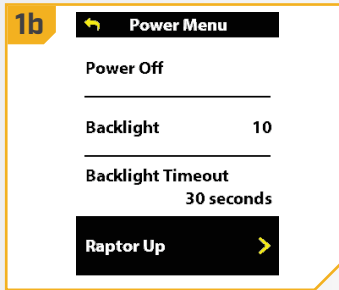

WARNING





Be sure that the Raptor is clear of obstructions and persons while deploying or retracting. Take care that neither you nor other persons approach the Raptor too closely, while operating, neither with body parts nor with objects. The Raptor is powerful and may endanger or injure you or others. While the Raptor is operating, watch out for persons swimming and for floating objects. Persons who lack the ability to run the Raptor or whose reactions are impaired by alcohol, drugs, medication, or other substances are not permitted to use this product.

CAUTION

The spaces between the Outer Arm, Inner Arm, Spike and brackets of the Raptor can create a pinch point. Do not come into contact with an area of the Raptor that may cause a pinch point when it is moving in any direction to avoid risk.

SHALLOW WATER ANCHOR CONTROLS

2

- e. While the Raptor is stowing, it is possible to pause the action. To pause the action, make sure that Raptor Pause is highlighted. Use the Speed Up  or Speed Down  button to highlight Raptor Pause.
- f. Press Steer Right  button to select it. A banner will appear at the bottom of the screen for three seconds that displays Raptor Paused.
- g. To resume stowing the Raptor, press Steer Right  button to select Raptor Up.
- h. Once the retracting anchor on the Raptor gets to its fully retracted state, it will stop.

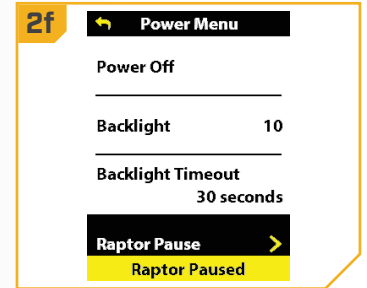
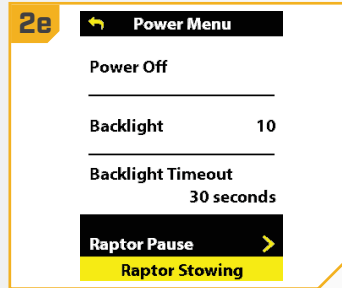







REMOTE CONTROLS

› To Adjust the Backlight

Use the Power Menu on the Wireless Remote to adjust the backlight intensity. It can be set to either "off" or a range of one to five. The default is "off".

1

- Press the Power  button.
- Use the Speed Up  or Speed Down  button to find Backlight. Use the Steer Right  button to select Backlight.
- Use the Steer Left  or Steer Right  button to adjust the Backlight brightness from "off" to 5.
- Once the desired brightness is found, press the Power  button again to exit the menu.



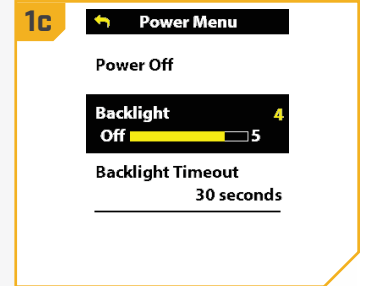
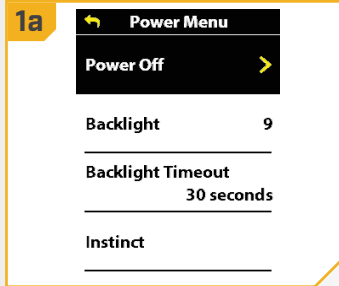





NOTICE: Remote battery life is subject to frequency of use and is especially impacted by how bright the LCD backlight is set.



› To Adjust the Backlight Timeout

Use the Power Menu on the Wireless Remote to adjust the backlight timeout duration. It can be set to 10 seconds, 30 seconds, 1 minute, 5 minutes, and Always On. The default is 30 seconds.

1

- Press the Power  button.
- Use the Speed Up  or Speed Down  button to find Backlight Timeout. Use the Steer Right  button to select Backlight Timeout.
- In the Backlight Timeout menu, use the Speed Up  or Speed Down  button to select a timeout option.
- Once the desired timeout is found, Use the Steer Right  button to make the selection. The radio button to the right of the timeout will be highlighted when the option is selected.
- Press the Power  button again to exit the menu.

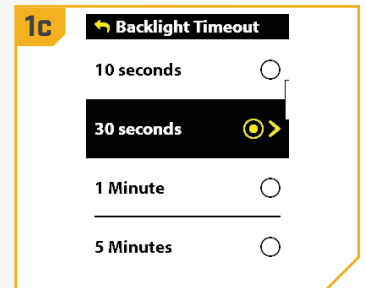
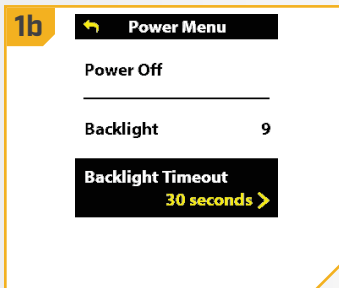







NOTICE: Remote battery life is reduced when longer backlight timeouts are selected.

› To Adjust the Theme

Use the Preferences Menu on the Wireless Remote to set the Display Theme to either Light mode or Dark mode. Dark is the default.

1

- a. Press the Menu  button.
- b. Use the Speed Up  or Speed Down  button to find Preferences. Use the Steer Right  button to select Preferences.
- c. In the Preferences Menu, use the Speed Up  or Speed Down  button to find Theme. Press the Steer Right  button to select Theme.

1b

← Terrova 3.0

My Data

Preferences >

Bluetooth _____

System _____

1c

← Preferences





Theme Light >

Language _____ English

Units _____

Time _____

2

- d. Use the Speed Up  or Speed Down  button to select the Light or Dark theme. Press the Steer Right  button to make the selection.
- e. Press and hold the Menu  button to return to the Dashboard.

2d

← Theme







Light >

Dark

› Selecting Remote Language

Use the Preferences Menu on the Wireless Remote to choose between one of twenty-two languages. The default language is English.

1

- a. Press the Menu  button.
- b. Use the Speed Up  or Speed Down  button to find Preferences. Use the Steer Right  button to select Preferences.
- c. In the Preferences Menu, use the Speed Up  or Speed Down  button to find Language. Press the Steer Right  button to select Language.

1b

← Terrova 3.0

My Data

Preferences >

Bluetooth _____

System _____

1c

← Preferences

Theme Light

Language English >

Units _____





Time _____

 **WARNING**

Be aware of accidental or unintentional contact with the Wireless Remote to avoid an accidental motor operation, including accidental language selection. You must always be prepared to regain manual control of your boat. Learn to operate your Minn Kota product in an area free from hazards and obstacles. To restore the Wireless Remote, perform Restore System Default.

REMOTE CONTROLS

2







- d. Use the Speed Up  or Speed Down  button to select an available language. Press the Steer Right  button to make the selection.
- e. Press and hold the Menu  button to return to the Dashboard.



Change the Distance Units





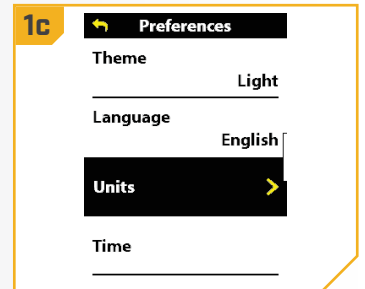
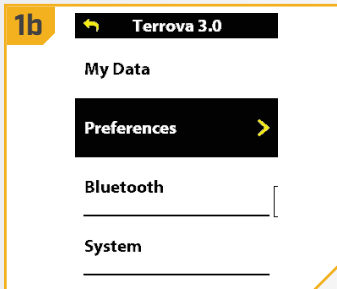

Use the Preferences Menu on the Wireless Remote to set the unit of measurement for distance in Feet or Meters. The default is set to Feet.

1

- a. Press the Menu  button.
- b. Use the Speed Up  or Speed Down  button to find the Preferences. Use the Steer Right  button to select Preferences.
- c. In the Preferences Menu, use the Speed Up  or Speed Down  button to find Units. Press the Steer Right  button to select Units.







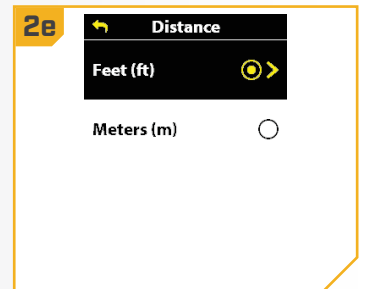
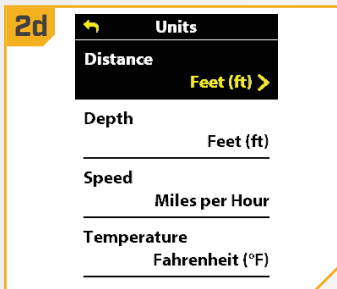

2

- d. In the Units menu, use the Speed Up  or Speed Down  button to find Distance. Press the Steer Right  button to select Distance.
- e. Use the Speed Up  or Speed Down  button to select Feet or Meters. Press the Steer Right  button to make the selection.
- f. Press and hold the Menu  button to return to the Dashboard.







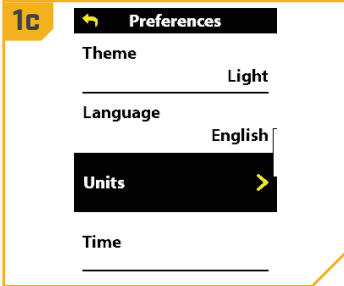
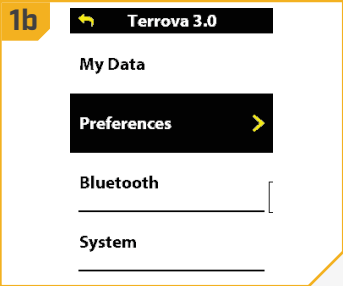

Change the Depth Units

Use the Preferences Menu on the Wireless Remote to set the unit of measurement for depth in Feet or Meters. The default is set to Feet.

- 1 a. Press the Menu  button.
- b. Use the Speed Up  or Speed Down  button to find Preferences. Use the Steer Right  button to select Preferences.
- c. In the Preferences Menu, use the Speed Up  or Speed Down  button to find Units. Press the Steer Right  button to select Units.





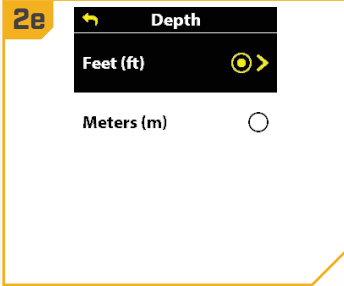
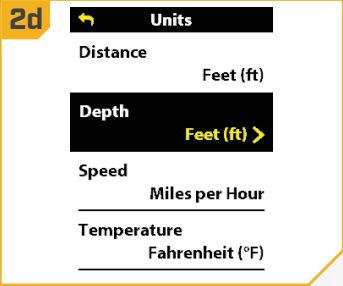



- 2 d. In the Units menu, use the Speed Up  or Speed Down  button to find Depth. Press the Steer Right  button to select Depth.
- e. Use the Speed Up  or Speed Down  button to select Feet or Meters. Press the Steer Right  button to make the selection.
- f. Press and hold the Menu  button to return to the Dashboard.



Change the Speed Units





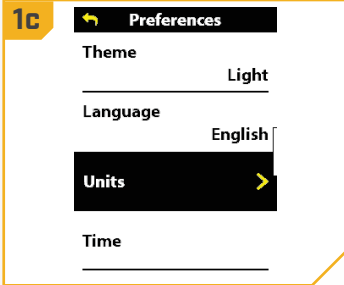
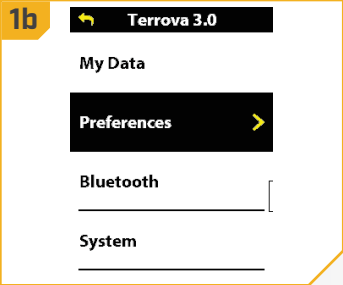

Use the Preferences Menu on the Wireless Remote to set the speed measurements in units of mph (miles per hour) or kph (kilometers per hour). The default is set to mph.

- 1 a. Press the Menu  button.
- b. Use the Speed Up  or Speed Down  button to find Preferences. Use the Steer Right  button to select Preferences.
- c. In the Preferences Menu, use the Speed Up  or Speed Down  button to find Units. Press the Steer Right  button to select Units.



REMOTE CONTROLS

2



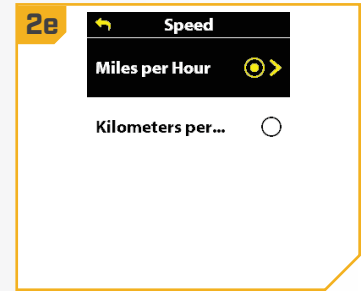
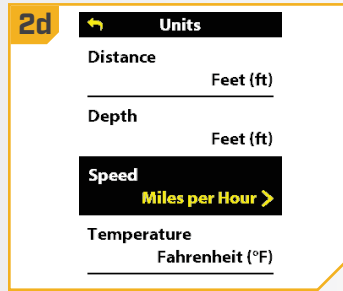



- d. In the Units menu, use the Speed Up  or Speed Down  button to find Speed. Press the Steer Right  button to select Speed.
- e. Use the Speed Up  or Speed Down  button to select Miles per Hour or Kilometers per Hour. Press the Steer Right  button to make the selection.
- f. Press and hold the Menu  button to return to the Dashboard.



Change the Temperature Units





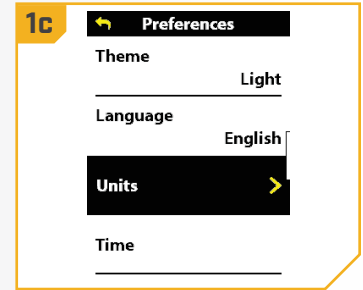
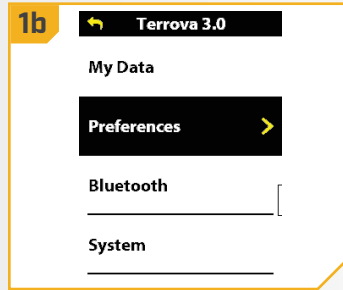

Use the Preferences Menu on the Wireless Remote to set the temperature readings to Fahrenheit or Celsius. The default is set to Fahrenheit.

1

- a. Press the Menu  button.
- b. Use the Speed Up  or Speed Down  button to find Preferences. Use the Steer Right  button to select Preferences.
- c. In the Preferences Menu, use the Speed Up  or Speed Down  button to find Units. Press the Steer Right  button to select Units.



2



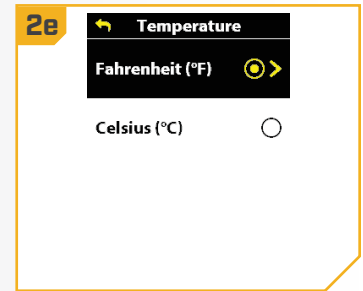
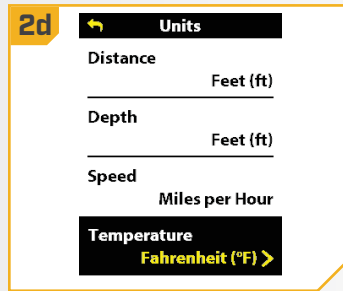



- d. In the Units menu, use the Speed Up  or Speed Down  button to find Temperature. Press the Steer Right  button to select Temperature.
- e. Use the Speed Up  or Speed Down  button to select Fahrenheit or Celsius. Press the Steer Right  button to make the selection.
- f. Press and hold the Menu  button to return to the Dashboard.



Change the Time Format





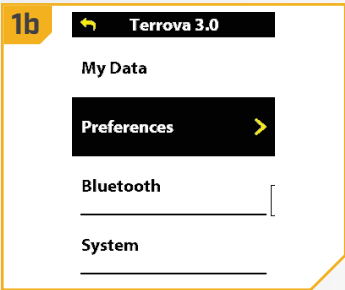

Use the Preferences Menu on the Wireless Remote to set the time format to 12 hours or 24 hours. The default is set to 12 hours.

1

- a. Press the Menu  button.
- b. Use the Speed Up  or Speed Down  button to find Preferences. Use the Steer Right  button to select Preferences.
- c. In the Preferences Menu, use the Speed Up  or Speed Down  button to find Time. Press the Steer Right  button to select Time.



2



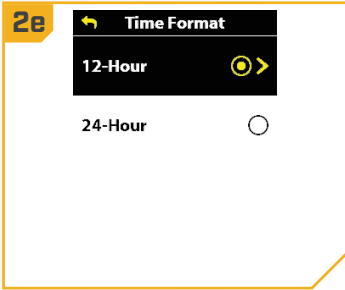
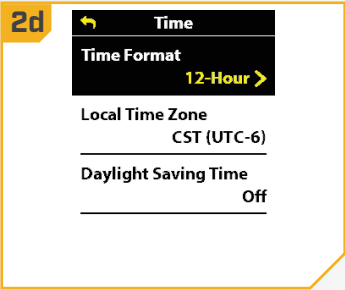



- d. In the Time menu, use the Speed Up  or Speed Down  button to find Time Format. Press the Steer Right  button to select Time Format.
- e. Use the Speed Up  or Speed Down  button to select 12-Hour or 24-Hour. Press the Steer Right  button to make the selection.
- f. Press and hold the Menu  button to return to the Dashboard.



Change the Time Zone

Use the Preferences Menu on the Wireless Remote to choose between thirty-five local time zones. The default is set to CST.





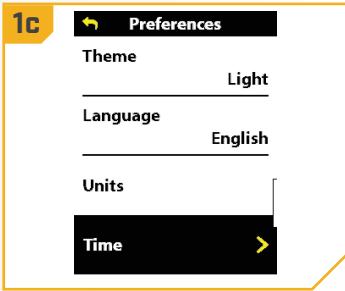
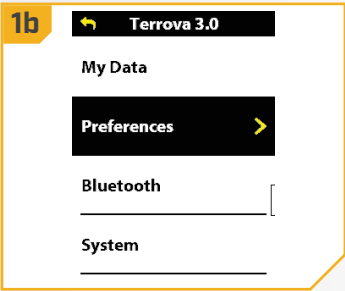

1

- a. Press the Menu  button.
- b. Use the Speed Up  or Speed Down  button to find Preferences. Use the Steer Right  button to select Preferences.
- c. In the Preferences Menu, use the Speed Up  or Speed Down  button to find Time. Press the Steer Right  button to select Time.



REMOTE CONTROLS

2



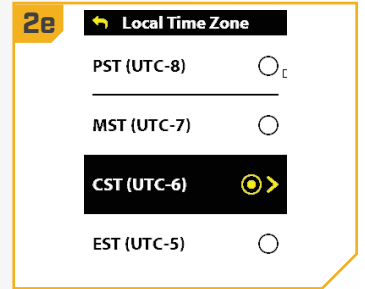
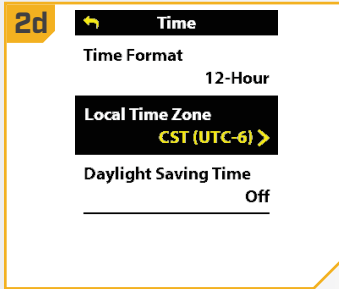



- d. In the Time menu, use the Speed Up  or Speed Down  button to find Local Time Zone. Press the Steer Right  button to select Local Time Zone.
- e. Use the Speed Up  or Speed Down  button to find the local time zone. Press the Steer Right  button to make the selection.
- f. Press and hold the Menu  button to return to the Dashboard.



> Toggle Daylight Savings



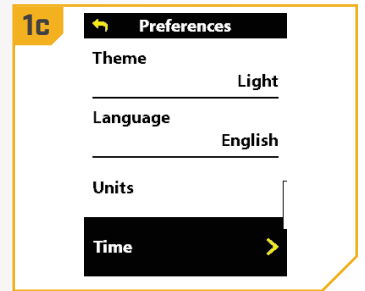
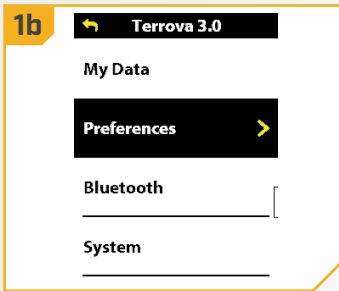

Use the Preferences Menu on the Wireless Remote to turn Daylight Saving Time to either "on" or "off." The default is set to "off."

1

- a. Press the Menu  button.
- b. Use the Speed Up  or Speed Down  button to find Preferences. Use the Steer Right  button to select Preferences.
- c. In the Preferences Menu, use the Speed Up  or Speed Down  button to find Time. Press the Steer Right  button to select Time.



2

- d. In the Time menu, use the Speed Up  or Speed Down  button to select Daylight Saving Time.
- e. Press the Steer Right  button to toggle Daylight Saving Time "on" or "off."
- f. Press and hold the Menu  button to return to the Dashboard.

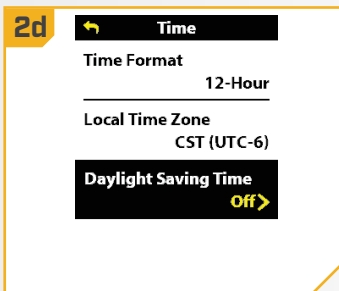







NOTICE: The Daylight Saving Time toggle automatically adjusts the display to the correct time when Daylight Savings Time is in effect. The adjustment is in effect when it is toggled to "on." It is not in effect when it is toggled to "off."

Change Power Off Time

Use the Preferences Menu on the Wireless Remote to set the period of inactivity required to automatically power off the Wireless Remote to 30, 60, 90 or 120 minutes. The default is set to 120 minutes.

1

- a. Press the Menu  button.
- b. Use the Speed Up  or Speed Down  button to find Preferences. Use the Steer Right  button to select Preferences.
- c. In the Preferences Menu, use the Speed Up  or Speed Down  button to find Power Off Time. Press the Steer Right  button to select Power Off Time.



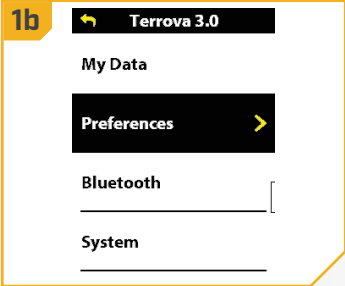

1b



1c



2

- d. Use the Speed Up  or Speed Down  button to select a Power Off Time interval. Press the Steer Right  button to make the selection.
- e. Press and hold the Menu  button to return to the Dashboard.

2d

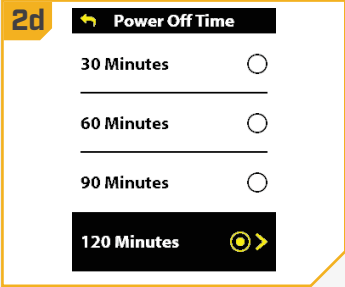







SERVICE & MAINTENANCE

› To Open the Diagnostic Screen

When opening the Diagnostic Screen, the screen will display information on Error Codes, Motor Battery Status, Remote Battery, Motor Heading, and Boat Heading.

1

- Press the Menu  button.
- Use the Speed Up  or Speed Down  button to find System. Use the Steer Right  button to select System.
- In the System Menu, use the Speed Up  or Speed Down  button to find Diagnostic. Press the Steer Right  button to select Diagnostic.
- Information about the Error Codes, Battery, Motor Heading and Heading Sensor will appear on the screen.

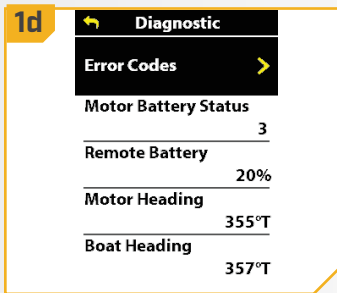
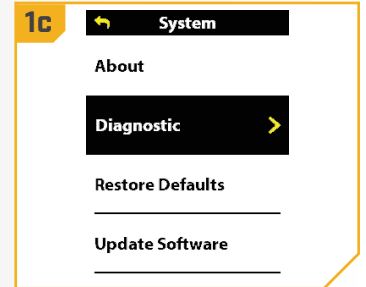
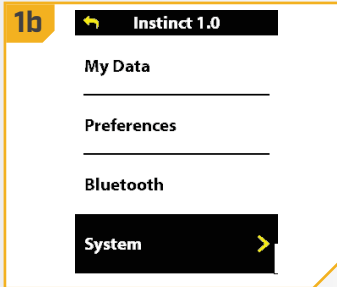





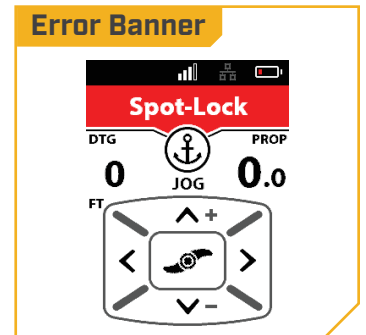
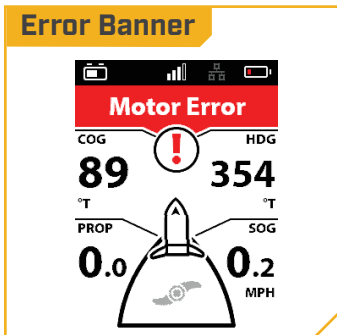

› View Error Codes

If the trolling motor senses an error, it will send a signal to the Wireless Remote, and a red banner will appear on the display screen. Use the Diagnostic Menu to view the associated Error Code, and then reference the Error Code Table in this manual to resolve the error.



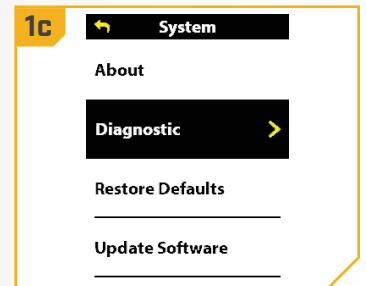
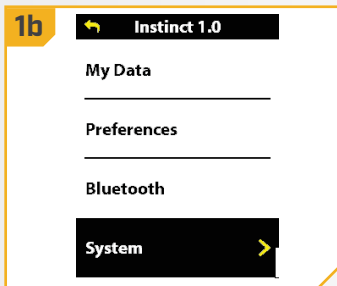

1

- Press the Menu  button.
- Use the Speed Up  or Speed Down  button to find System. Use the Steer Right  button to select System.
- In the System Menu, use the Speed Up  or Speed Down  button to find Diagnostic. Press the Steer Right  button to select Diagnostic.



2

- d. Use the Speed Up  or Speed Down  button to find Error Codes. Press the Steer Right  button to select Error Codes.
- e. If there is an Error Code, the Error Code will be displayed on the screen. Refer to the table below for a description of the Error Code.
- f. If there are no Error Codes to display, the display screen will show No Error Codes.

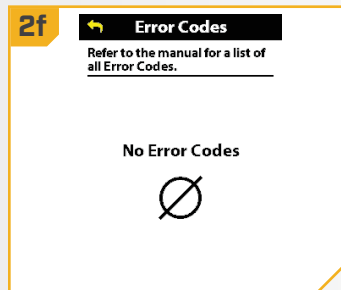
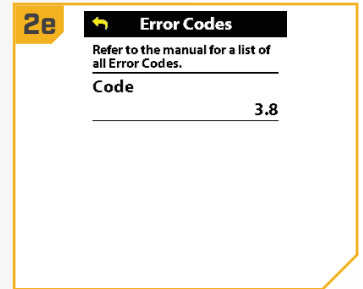
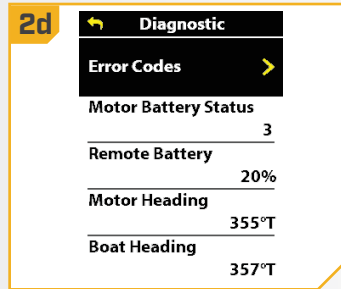

Error Code	Error Name	Motor Effect	Possible Recovery Action(s)
1.1	Battery voltage too high	LED flashes red. Lower unit turns off. Prop and steering are disabled.	Check voltage of batteries. If high, check for battery charger malfunction, or check if too many batteries are connected in series. Power cycle to reset.
1.2	Battery voltage too low	LED flashes red. Lower unit turns off. Prop and steering are disabled. Trim and steering are disabled (RT Instinct QUEST/Ulterra QUEST/Ulterra).	Check battery connection. Charge trolling motor batteries. Power cycle to reset.
1.3	Steering circuit failure	LED flashes red. Lower unit turns off. Prop and steering are disabled.	Power cycle to reset.
1.4	Lower unit over-heated	LED flashes red. Lower unit turns off. Prop and steering are disabled.	Lower unit needs to cool down. Power cycle to reset.
1.5	Excessive current to lower unit	LED flashes red. Lower unit turns off. Prop and steering are disabled.	Power cycle to reset.
1.6	Excessive current to lower unit when Prop is off	LED flashes red. Lower unit turns off. Prop and steering are disabled.	Power cycle to reset.
1.7	Pre-charge circuit failure	LED flashes red. Lower unit turns off. Prop is disabled. Steering is disabled on Terrova QUEST and Ultrex QUEST.	Power cycle to reset.
1.8	Stow/deploy horizontal sensors are reporting active at the same time	Prop, trim, steering and stow/deploy are disabled.	Service required; contact Minn Kota Authorized Service Center for service.
1.9	Small motor pre-charge failed	LED flashes red. Trim, steering, and tilt are disabled on Ulterra QUEST and RT Instinct QUEST.	Power cycle to reset.
2.1	Over-current trip on lower unit/inverter	The inverter stops the motor.	Toggle the Prop after the fault is cleared.
2.2	Lower unit/inverter synchronization error	The inverter stops the motor.	Toggle the Prop after the fault is cleared.

SERVICE & MAINTENANCE









Error Code	Error Name	Motor Effect	Possible Recovery Action(s)
2.3	Loss of communication to inverter	The inverter stops the motor.	A loss of communications may require a power cycle. If communication is not restored, contact Minn Kota Authorized Service Center for service.
3.1	Steering position sensor communication error	Limited steering speed. No steering feedback. No Auto Park or Straight Ahead Deploy.	Try power cycle to reset. Contact Minn Kota Authorized Service Center for service.
3.2	Trim position sensor communication error	Reduced trim speed. Can only manually trim for 2 second intervals. No automatic stow or deploy.	Try power cycle to reset. Contact Minn Kota Authorized Service Center for service.
3.3	Loss of magnet from steering position sensor	Limited steering speed. No steering feedback. No Auto Park or Straight Ahead Deploy.	Try power cycle to reset. Contact Minn Kota Authorized Service Center for service.
3.4	Loss of magnet from trim position sensor	Reduced trim speed. Can only manually trim for 2 second intervals. No automatic stow or deploy.	Try power cycle to reset. Contact Minn Kota Authorized Service Center for service.
3.5	Stow/deploy sensor error	Prop turns off and stow LED turns off. Disables stow/deploy for RT Instinct QUEST/Ultrerra QUEST.	RT Instinct QUEST/Ultrerra QUEST: Check if actuator is stuck or if the magnet fell out. Terrova QUEST: If ramps flipped up while deployed, flip them back down. If sensors are damaged, contact Minn Kota Authorized Service Center for service.
3.6	Deploy and horizontal sensors reporting active at same time	Prop, trim, steering, and stow/deploy are disabled.	Sensor is damaged. Contact Minn Kota Authorized Service Center for service.
3.7	Emergency release pin sensor is reporting inactive	Prop and stow/deploy process are disabled.	Sensor is damaged. Contact Minn Kota Authorized Service Center for service.
3.8	End-of-Travel/Foot Pedal sensor reporting active at same time	Steering is not active.	Sensor is damaged. Contact Minn Kota Authorized Service Center for service.
3.9	Foot pedal pressure sensor failure	Steering is not active from the foot pedal.	Sensor is damaged. Contact Minn Kota Authorized Service Center for service.
3.10	Stow/lever sensors reporting active at the same time	Prop off and stow LED is off. Steering could be limited.	Sensor is damaged. Contact Minn Kota Authorized Service Center for service.
3.11	Stow/deploy/lever sensor reporting active	Prop off and stow LED is off. Steering could be limited.	Sensor is damaged. Contact Minn Kota Authorized Service Center for service.
3.12	Steering calibration values are out of range	Steering range is limited.	Contact Minn Kota customer service or Authorized Service Center to perform steering calibration.
4.1	Steering motor exceeds current limit	Steering time-outs will occur if current limit can be maintained or until torque on shaft is reduced.	Re-initiate steering by steering left or right.
4.6	Trim motor exceeds current limit	Disables trim.	Reinitiate trim by trimming in opposite direction.
4.8	Tilt motor exceeds current limit	Stops stow/deploy.	Auto-cleared. Re-initiate stow or deploy.



Restore System Defaults



Use the System Menu on the Wireless Remote to restore defaults to the factory settings.

1

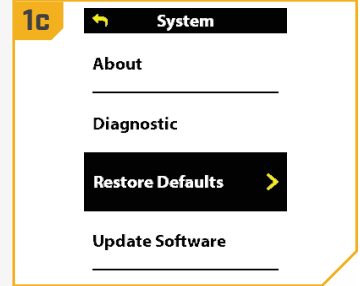
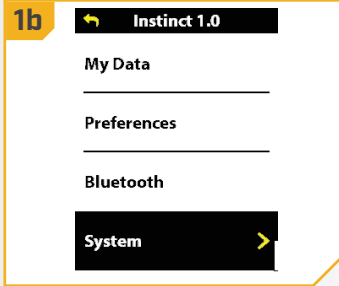
- a. Press the Menu  button.
- b. Use the Speed Up  or Speed Down  button to find System. Use the Steer Right  button to select System.
- c. In the System Menu, use the Speed Up  or Speed Down  button to find Restore Defaults. Press the Steer Right  button to select Restore Defaults.



2





- d. The Restore Defaults screen appears. Please note the on-screen prompt. Use the Speed Up  or Speed Down  button to scroll to Confirm.

⚠ CAUTION

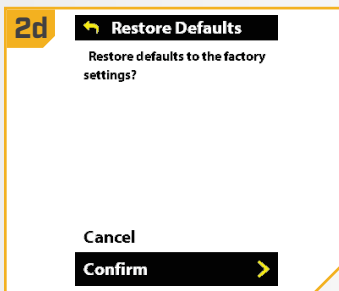
This will restore the remote's factory settings!

If the remote is connected to a trolling motor when the Defaults are restored, the Advanced GPS Navigation controller settings, such as Keel Offset, Prop Auto On, etc., will be restored to their default settings as well.



- e. Press the Steer Right  button to select Confirm. Selecting Confirm will restore the system's factory settings. The remote will reboot during the restore process.
- f. To exit the menu without restoring the remote, use the Speed Up  or Speed Down  button to scroll to Cancel. Press the Steer Right  button to select Cancel.

SERVICE & MAINTENANCE







ADVANCED GPS NAVIGATION SYSTEM SOFTWARE

CHECKING & UPDATING SOFTWARE >

> To Open the About Screen



When opening the About Screen, the screen will display the Wireless Remote and controller software version.

1

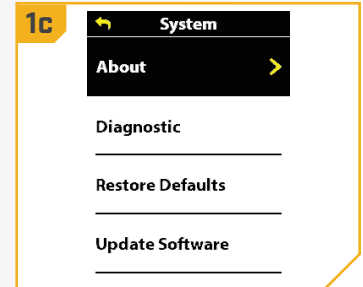
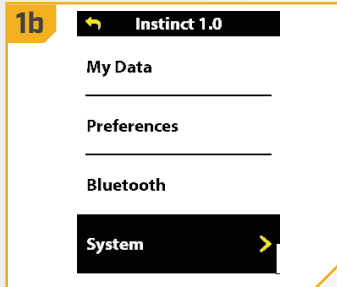
- a. Press the Menu  button.
- b. Use the Speed Up  or Speed Down  button to find System. Press the Steer Right  button to select System.
- c. Once in the System menu, use the Speed Up  or Speed Down  button to find About. Press the Steer Right  button to select About.



2

- d. The About Menu will provide information about the Software Package, Controller, or Remote. Use the Speed Up  or Speed Down  button to scroll through the different options.
- e. Press the Steer Right  button to view more information about each.

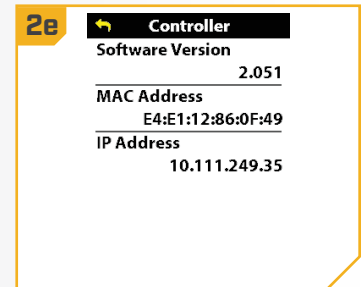
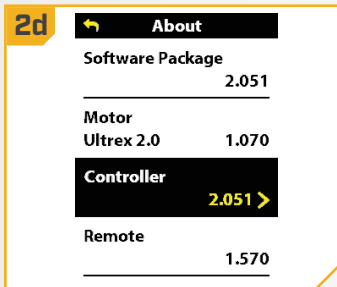







› Update Wireless Remote Software

Use the System Menu on the Wireless Remote to update software for the Wireless Remote.

The Wireless Remote software is updated through the motor Controller. First, make sure that the Controller software is up-to-date before starting the Wireless Remote software update. See the One-Boat Network App User Manual for more information on updating the Controller.

1

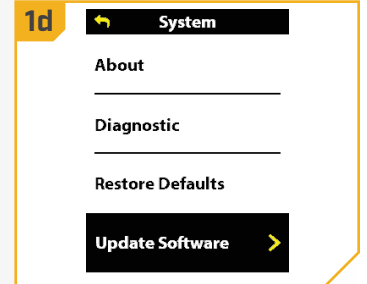
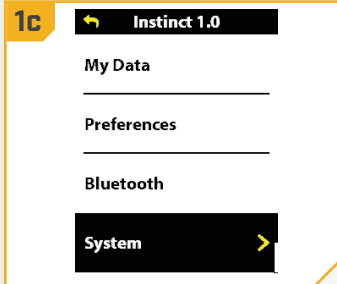

NOTICE: The software update for the Wireless Remote will come from the trolling motor. Make sure the Wireless Remote stays within range of the Control Head during the update process.

- a. Be sure that the software in the Control Head is updated before updating the Wireless Remote.
- b. Once the Control Head is up-to-date, press the Menu  button.
- c. Use the Speed Up  or Speed Down  button to find System. Use the Steer Right  button to select System.
- d. Once in the System menu, use the Speed Up  or Speed Down  button to find Update Software. Press the Steer Right  button to select Update Software.



SERVICE & MAINTENANCE

2

- e. If the software is up-to-date, the screen will display "No New Software Found" and will list the current version installed. Press the Steer Right  button to cancel.
- f. If the software is not up-to-date, the display screen will read "New Software Available" and will list the current version installed and the new version that can be installed. Use the Speed Up  or Speed Down  button to scroll to Update.

NOTICE: After selecting the Update Software option, take note of the software version that the Wireless Remote will be updated to. Noting the software version will be helpful to confirm that the software successfully updated after the remote cycles through the update.



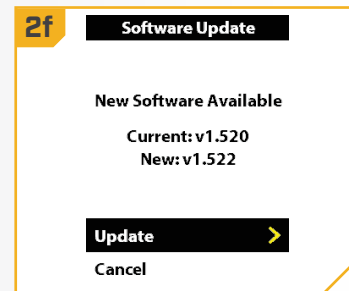
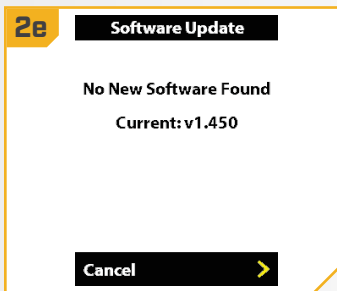



- g. Press the Steer Right  button to select Update. Once the software has been downloaded, the display screen will reboot and the Wireless Remote will power up and return to the home screen. To confirm that the software successfully updated, follow the steps in the "To Open the About Screen" section of this manual.



PAIRING A REMOTE WITH A CONTROLLER



PAIRING A REMOTE >

The Advanced GPS Navigation controller in the trolling motor Control Head may pair up to three remotes. These three remotes can be a combination of the standard Wireless Remotes and Micro Remotes. In addition, the controller can be paired to one mobile device for the One-Boat Network Application. If the trolling motor came with the full-featured Advanced GPS Navigation Wireless Remote, it came already paired to the trolling motor from the factory. Any additional remotes can be paired using the following steps. Once the maximum number of remotes have been paired, the controller will start replacing the oldest paired remote in memory with the new remote.

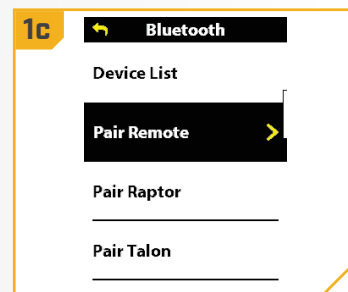
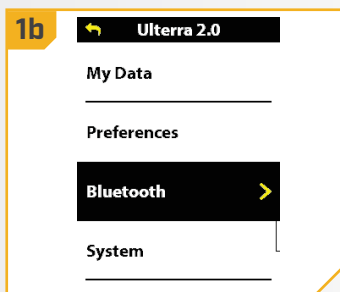
- 1
 - a. Press the Menu  button.
 - b. Use the Speed Up  or Speed Down  button to find Bluetooth. Use the Steer Right  button to select Bluetooth.
 - c. In the Bluetooth Menu, use the Speed Up  or Speed Down  button to find Pair Remote. Press the Steer Right  button to select Pair Remote.



NOTICE: Make sure the remote stays within range of the Control Head during the pairing process.

- 2
 - d. To pair the Wireless Remote to the trolling motor, enable Pairing Mode on the trolling motor. Press and hold the Pair button on the trolling motor's control head. The trolling motor will emit a continuous tone while in Pairing Mode.
 - e. On the remote, use the Steer Right  button to select Pair to Motor. The remote will scan for the motor. Continue to hold the Pair button on the trolling motor during this process.
 - f. If successfully paired, the trolling motor will emit three beeps and the remote will be paired. The Pair button may be released.
 - g. If 30 seconds pass while in Pairing Mode and the pair is not successful, an error tone will sound from the trolling motor, signaling that the pairing has timed out. If unsuccessful, repeat the process.
 - h. When complete, press and hold the Menu  button to return to the Dashboard.

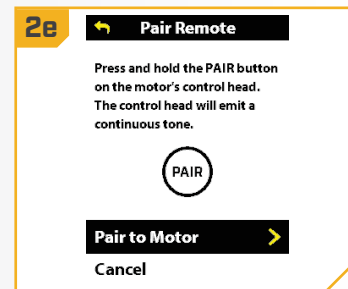
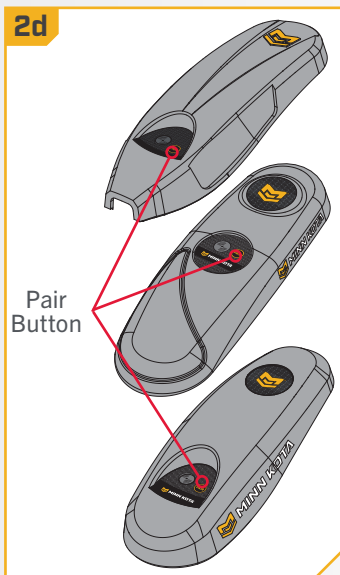

SERVICE & MAINTENANCE

TALON WITH THE ADVANCED GPS NAVIGATION SYSTEM

PAIRING, CHECKING & UPDATING SOFTWARE >

> Pair the Advanced GPS Navigation System to a Single Talon

The Advanced GPS Navigation system is paired to the Talon using the trolling motor Control Head and the Up ▲ and Down ▼ Buttons on the Talon Indicator Panel.

- 1**
 - a. Retract the anchor on the Talon by pressing the Up ▲ button.
 - b. Once the Talon is fully retracted, press and hold the Up ▲ button and the Down ▼ button simultaneously on the Indicator Panel. The Depth Indication LEDs will begin to flash blue. Once the LEDs are flashing, release the buttons on the Indicator Panel.
 - c. The Talon will go into Pairing Mode for 20 seconds.
 - d. Locate the Pair Button on the top of the Control Head. Press and hold the Pair button. A consistent tone will be emitted from the Control Head.
 - e. The Control Head will scan for the Talon. Once successfully paired, three longer beeps will be emitted from the Control Head and the Talon. The LEDs on the Indicator Panel of the Talon will perform a sequence to confirm that the Control Head and Talon are paired.
 - f. If 20 seconds pass while in Pairing Mode and they do not successfully pair, a chirp from the Talon will sound signaling that the Pairing has timed out.
 - g. If the Pair is unsuccessful, repeat the process.

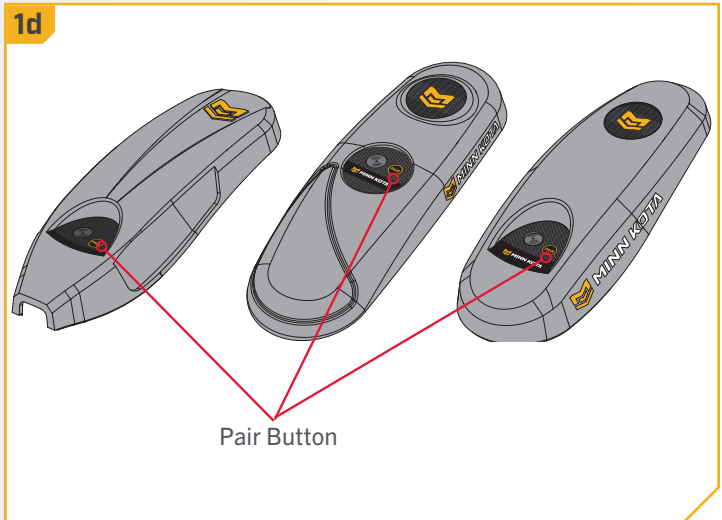

> Pairing the GPS Navigation System with Two Talons



In order for the Advanced GPS Navigation System to be paired to two Talons, the Talons first need to be paired together. To learn how to pair two Talons together, read the "Pairing Two Talons and Programming the Mounting Location" section of the Talon Manual. Once the Talons are paired together, follow the directions for "Pair the GPS Navigation System to a Single Talon." Only one Talon needs to be paired with the Advanced GPS Navigation system.

RAPTOR WITH THE ADVANCED GPS NAVIGATION SYSTEM

PAIRING, CHECKING & UPDATING SOFTWARE

Pair the Advanced GPS Navigation System to a Single Raptor

The Advanced GPS Navigation system is paired to the Raptor using the trolling motor Control Head and the PAIR button on the Raptor Indicator Panel.

- 1
 - a. Retract the anchor on the Raptor by pressing the Up  button in the Indicator Panel.
- NOTICE:** The Indicator Panel on the Raptor is located on the Raptor Pump Assembly.
- b. To pair the Wireless Remote to the Raptor, press the PAIR  button on the Indicator Panel. The PAIR/Maintenance LED will begin to flash  blue.
 - c. The Raptor will go into Pairing Mode for 30 seconds.
 - d. Locate the Pair Button on the top of the Control Head. Press and hold the Pair button. A consistent tone will be emitted from the Control Head.
 - e. The Control Head will scan for the Raptor. Once successfully paired, three longer beeps will be emitted from the Control Head and the Raptor.
 - f. If 30 seconds pass while in Pairing Mode and the pair is unsuccessful, a chirp from the Raptor will sound signaling that the Pairing has timed out.
 - g. If the Pair is unsuccessful, repeat the process.

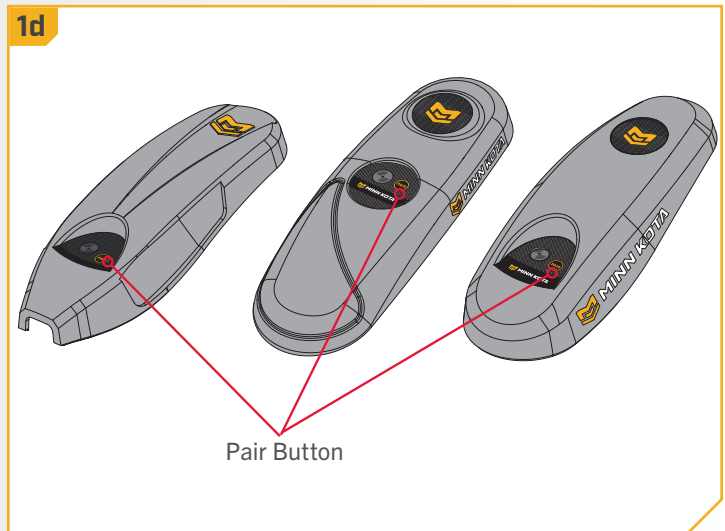
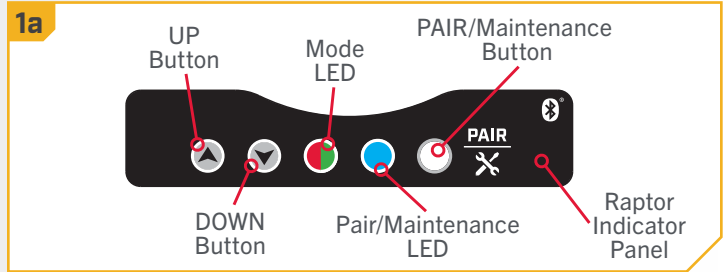

Pairing the GPS Navigation System with Two Raptors

In order for the Advanced GPS Navigation system to be paired to two Raptors, the Raptors first need to be paired together. To learn how to pair two Raptors together, read the "Pairing Two Raptors and Programming the Mounting Location" section of the Raptor Manual. Once the Raptors are paired together, follow the directions for "Pair the GPS Navigation System to a Single Raptor." Only one Raptor needs to be paired with the Advanced GPS Navigation System.







SERVICE & MAINTENANCE

BLUETOOTH DEVICE LIST

MANAGING BLUETOOTH DEVICE LIST >



> Manage Bluetooth Devices

1

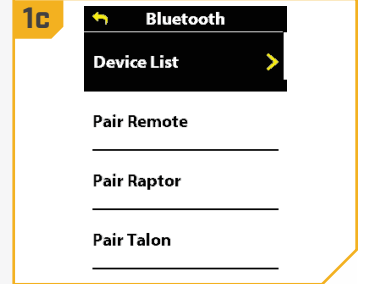
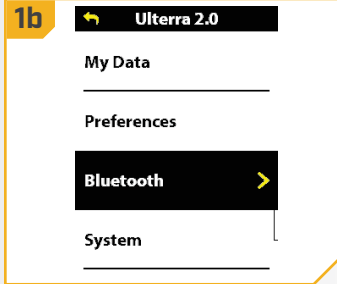
- a. Press the Menu  button.
- b. Use the Speed Up  or Speed Down  button to find Bluetooth. Use the Steer Right  button to select Bluetooth.
- c. In the Bluetooth Menu, use the Speed Up  or Speed Down  button to find Device List. Press the Steer Right  button to select Device List.



2



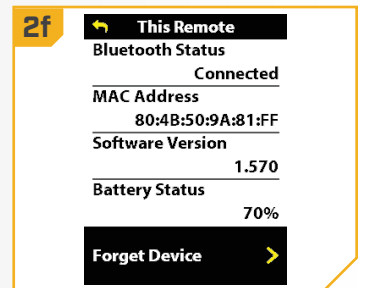
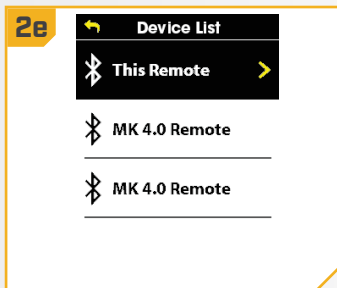



- d. The Device List shows all Bluetooth connected devices.
- e. Use the Speed Up  or Speed Down  button to select the device to view. Use the Steer Right  button to select it.
- f. The Device Menu provides the Bluetooth connection status, the MAC address, the software version, the battery status, and an option to forget the device from the network.



› To Forget Paired Devices

It may be necessary to forget any devices that are paired to the Advanced GPS Navigation system. To forget all devices, including the Wireless Remote, follow the steps below.

1

- a. Press the Menu  button.
- b. Use the Speed Up  or Speed Down  button to find Bluetooth. Press the Steer Right  button to select Bluetooth.
- c. Once in the Bluetooth menu, use the Speed Up  or Speed Down  button to find Restore Network. Press the Steer Right  button to select Restore Network.



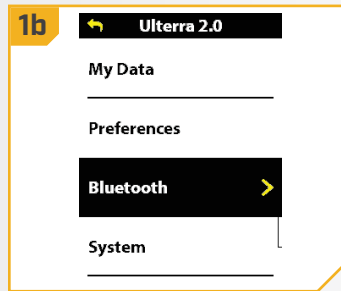

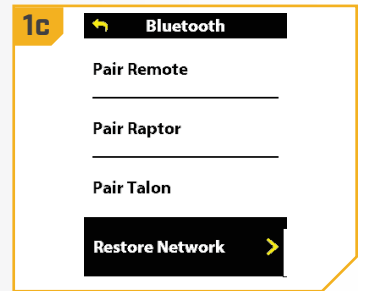

1b



1c



2

- d. The Restore Network options appear. Please note the on-screen prompt.
- e. Use the Speed Up  or Speed Down  button to scroll to Confirm. Press the Steer Right  button to select Confirm.
- f. Selecting Confirm will forget all devices paired to the trolling motor.
- g. To exit the menu and keep all paired devices on the network, use the Speed Up  or Speed Down  button to scroll to Cancel. Press the Steer Right  button to select Cancel.

2e



SERVICE & MAINTENANCE



GENERAL MAINTENANCE

- Connect the motor to a power source to power up the Control Head before use.
- Check the Wireless Remote batteries each time the remote is powered up.
- Inspect the Wireless Remote and Control Head before each use to make sure that the path of communication is not obstructed. Having a clear view from the Control Head to the sky and an unobstructed sight line between the Wireless Remote and Control Head will allow for proper communication.
- Keep the Control Head and Wireless Remote away from metal objects, including aluminum. Metal objects will cause interference.
- Power down the Wireless Remote and disconnect the motor from a power source after each use.
- Verify that the Prop on the trolling motor is unobstructed when running. Obstructions can lead to interference and vibration of the compass in the Control Head.

TROUBLESHOOTING

1. The motor is making erratic steering corrections while in a mode of navigation.
 - For trolling motors with an internal Heading Sensor, make sure to set the Keel Mount Offset. Refer to the "Keel Mount Offset" section of the manual for more information.
 - Be sure to keep all ferrous metallic objects away from the Advanced GPS controller in the Control Head, as they will have an impact on the built-in compass. Ferrous materials include materials made of lead or nickel, such as a boat anchor, etc.
2. When a button on the remote is pressed, the motor does not always respond.
 - Check if the low battery indicator is on. If so, replace the remote's battery. Check for large obstructions between the remote and the motor.
3. When a button on the Wireless Remote is pressed and nothing happens.
 - If the battery is dead, replace the batteries. Open the remote battery door and verify the batteries are properly connected to the remote.
4. Advanced GPS Navigation will not engage certain features like: AutoPilot, Record, Go To, Cruise Control or Spot-Lock.
 - Verify that the GPS Signal Strength icon on the LCD shows at least one bar. If there are no bars, the Advanced GPS Navigation system cannot establish a connection and will not allow GPS-based features to be enabled.

NOTICE: For all other malfunctions, visit an Authorized Service Center. You can search for an Authorized Service Center in your area by visiting our Authorized Service page, found online at minnkota.johnsonoutdoors.com, or by calling our customer service number at 800-227-6433.



FOR FURTHER TROUBLESHOOTING AND REPAIR

We offer several options to help you troubleshoot and/or repair your product. Please read through the options listed below.

Buy Parts Online

You can buy parts on-line directly from our website at minnkota.johnsonoutdoors.com. From screws to sideplates, you can order replacement parts for your Minn Kota products.

Frequently Asked Questions

Find answers to general inquiries, battery and rigging installation, and networking scenarios. We have FAQs available on our website at minnkota.johnsonoutdoors.com to help answer all of your Minn Kota questions.

Call Us (for U.S. and Canada)

Our consumer service representatives are available Monday – Friday between 7:00 a.m. – 4:30 p.m. CST at 800-227-6433. If you are calling to order parts, please have the 11-character serial number from your product, specific part numbers, and credit card information available. This will help expedite your call and allow us to provide you with the best consumer service possible. You can reference the parts list located in your manual to identify the specific part numbers.

Email Us

You can contact our consumer service department with questions regarding your Minn Kota products. To inquire, visit minnkota.johnsonoutdoors.com.

Authorized Service Centers

Minn Kota has over 800 authorized service centers in the United States and Canada where you can purchase parts or get your products repaired. Please visit our website to locate a service center in your area.



Scan to visit
Minn Kota
service online.



COMPLIANCE STATEMENTS

ENVIRONMENTAL COMPLIANCE STATEMENT

It is the intention of JOME to be a responsible corporate citizen, operating in compliance with known and applicable environmental regulations, and a good neighbor in the communities where we make or sell our products.

WEEE DIRECTIVE

EU Directive 2002/96/EC “Waste of Electrical and Electronic Equipment Directive (WEEE)” impacts most distributors, sellers, and manufacturers of consumer electronics in the European Union. The WEEE Directive requires the producer of consumer electronics to take responsibility for the management of waste from their products to achieve environmentally responsible disposal during the product life cycle.

WEEE compliance may not be required in your location for electrical & electronic equipment (EEE), nor may it be required for EEE designed and intended as fixed or temporary installation in transportation vehicles such as automobiles, aircraft, and boats. In some European Union member states, these vehicles are considered outside of the scope of the Directive, and EEE for those applications can be considered excluded from the WEEE Directive requirement.

This symbol (WEEE wheelee bin) on product indicates the product must not be disposed of with other household refuse. It must be disposed of and collected for recycling and recovery of waste EEE. Johnson Outdoors Inc. will mark all EEE products in accordance with the WEEE Directive. It is our goal to comply in the collection, treatment, recovery, and environmentally sound disposal of those products; however, these requirements do vary within European Union member states. For more information about where you should dispose of your waste equipment for recycling and recovery and/or your European Union member state requirements, please contact your dealer or distributor from which your product was purchased.

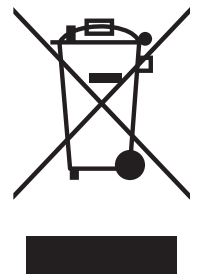

DISPOSAL

Minn Kota motors are not subject to the disposal regulations EAG-VO (electric devices directive) that implements the WEEE directive. Nevertheless never dispose of your Minn Kota motor in a garbage bin but at the proper place of collection of your local town council.

Never dispose of battery in a garbage bin. Comply with the disposal directions of the manufacturer or his representative and dispose of them at the proper place of collection of your local town council.

REGULATORY COMPLIANCE INFORMATION

➤ **Advanced GPS Navigation System: 2994192, 2994193, 2994194, 2994186, 2994197, 2994198, 2994199, 2994183, 2994187, 2994188, 2994189, 2994165, 2994167, 2994190, 2994195* & 2994191**

CONTROLLER

- Contains IC: 216Q-1316
- Contains FCC ID: T7V1316



REMOTE

- Contains IC: 5123A-GM220P
- Contains FCC ID: QoQ-GM220P



or

- Contains IC: 5123A-BGTBLE121LR
- Contains FCC ID: QoQBLE121LR



* Assembly 2994195 is not compliant in Korea.

FCC COMPLIANCE

This device complies with Part 15 of the FCC rules. Operation is subject to the following two conditions:

- 1. This device may not cause harmful interference.
2. This device must accept any interference that may be received, including interference that may cause undesired operation.

Changes or modifications not expressly approved by Johnson Outdoors Marine Electronics, Inc. could void the user's authority to operate this equipment.

NOTICE: This equipment has been tested and found to comply with the limits for a Class B digital device, pursuant to part 15 of the FCC Rules. These limits are designed to provide reasonable protection against harmful interference in a residential installation. This equipment generates, uses and can radiate radio frequency energy and, if not installed and used in accordance with the instructions, may cause harmful interference to radio communications. However, there is no guarantee that interference will not occur in a particular installation. If this equipment does cause harmful interference to radio or television reception, which can be determined by turning the equipment off and on, the user is encouraged to try to correct the interference by one or more of the following measures:

- Reorient or relocate the receiving antenna.
• Increase the separation between the equipment and receiver.
• Connect the equipment into an outlet on a circuit different from that to which the receiver is connected.
• Consult the dealer or an experienced radio/TV technician for help.

INDUSTRY CANADA COMPLIANCE

This product meets the applicable Industry Canada technical specifications. Operation is subject to the following two conditions: (1) this device may not cause interference, and (2) this device must accept any interference, including interference that may cause undesired operation of the device.

Changes or modifications not expressly approved by Johnson Outdoors Marine Electronics, Inc. could void the user's authority to operate this equipment.

RADIO OPERATION

CONTROLLER

- Frequency band: 2402 MHz to 2480 MHz
• Maximum RF power transmitted: +10 dBm

REMOTE

- Frequency band: 2402 MHz to 2480 MHz
• Maximum RF power transmitted: +10 dBm

TRADEMARKS

APEX™, AutoChart™, AutoPilot™, CoastMaster®, HELIX®, Humminbird®, Instinct™, LakeMaster®, Minn Kota®, One-Boat Network®, PowerDrive™, QUEST™, Riptide®, SOLIX®, Spot-Lock®, Terrova™, Ulterra®, Ultrex™ are trademarked by or registered trademarks of Johnson Outdoors Marine Electronics, Inc.

The Bluetooth® word mark and logos are registered trademarks owned by Bluetooth SIG, Inc. and any use of such marks by Johnson Outdoors Inc is under license. Other trademarks and trade names are those of their respective owners.



PARTS DIAGRAM & PARTS LIST

WIRELESS REMOTE

POWERDRIVE, RIPTIDE POWERDRIVE, TERROVA, RIPTIDE TERROVA, ULTREX, ULTERRA, RIPTIDE ULTERRA AND QUEST SERIES ULTREX, TERROVA, RIPTIDE TERROVA, ULTERRA AND RIPTIDE INSTINCT TROLLING MOTORS.

The parts diagram and parts list provides Minn Kota® WEEE compliance disassembly instructions. For more information about where you should dispose of your waste equipment for recycling and recovery and/or your European Union member state requirements, please contact your dealer or distributor from which your product was purchased. Tools required, but not limited to: flat head screwdriver, Phillips screwdriver, socket set, pliers, wire cutters.

WIRELESS REMOTE >

> Wireless Remote Parts Diagram

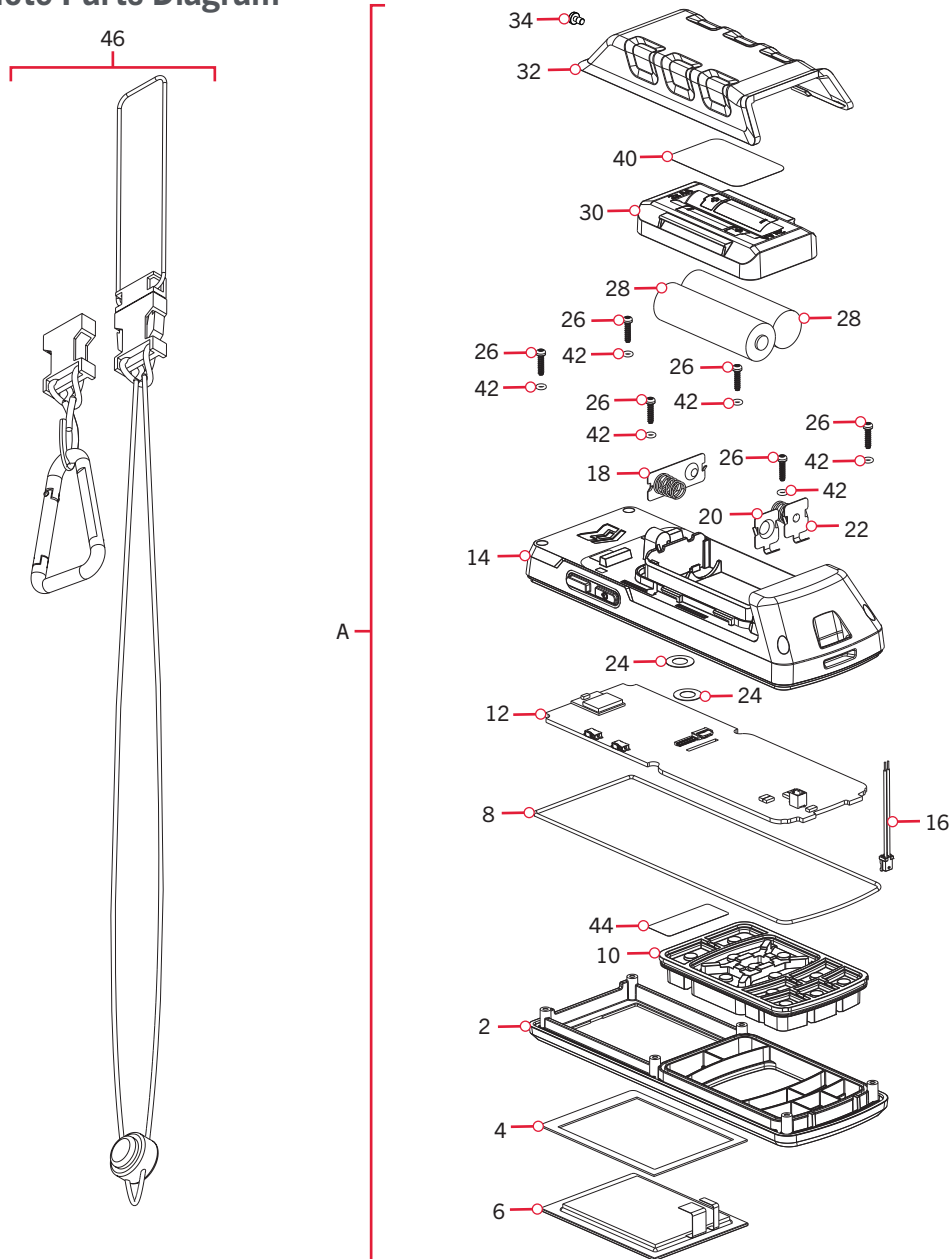

PARTS DIAGRAM & PARTS LIST

Wireless Remote Parts List

Assembly	Part #	Description	Notes	Quantity
A	411690-1	TROLLING MOTOR REMOTE		1
Item	Part #	Description	Notes	Quantity
2	✘	HOUSING, FRT- iPILOT 4.0 REMOT		1
4	✘	TAPE, VHB, LENS- iPILOT 4.0		1
6	✘	ASSY, DISP BND- iPILOT 4 REMOT		1
8	✘	GASKET- iPILOT 4.0 REMOTE		1
10	✘	KEYPAD- iPILOT 4.0 REMOTE		1
12	✘	ASSY, PCB- iPILOT 4.0 REMOTE		1
14	✘	HOUSING, REAR- iPILOT 4.0 REMT		1
16	✘	CABLE HARN, BAT- iPILOT 4 REMO		1
18	✘	CONTACT, AA, SPRING/BUTTON		1
20	✘	CONTACT, AA, BUTTON SOLDER LUG		1
22	✘	CONTACT, AA, SPRING SOLDER LUG		1
24	✘	VENT PATCH, YELLOW, .401" DIA		2
26	✘	SCREW, M2x8, DELTA T6 RH, SST		6
28	430022-1	BATTERY, AA		2
30	411679-1	COVER, BATTERY- iPILOT 4.0 REMO		1
32	411694-1	ASSY, DOOR, REAR- iPILOT 4.0 RE		1
34	2383442	SCREW-3MM X .5 PPH MACHINE		1
36 ▲	✘	E-CLIP, 3MM, SS		1
38	✘	O-RING, 1/16ID, 1/31 DIA, BUNA		1
40	✘	DECAL, COMPLIANCE- iPILOT 4.0		1
42	✘	O-RING, 1/16ID, 1/31 DIA, SIL		6
44	✘	LABEL, PACKOUT		1
46	2390802	LANYARD W/CARABINR, IP RMT		1

▲ Not shown on Parts Diagram.

✘ This part is included in an assembly and cannot be ordered individually.

PARTS DIAGRAM & PARTS LIST



WIRELESS REMOTE >

> Control Head Parts Diagram

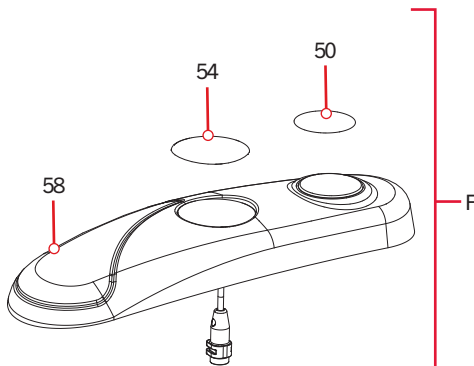
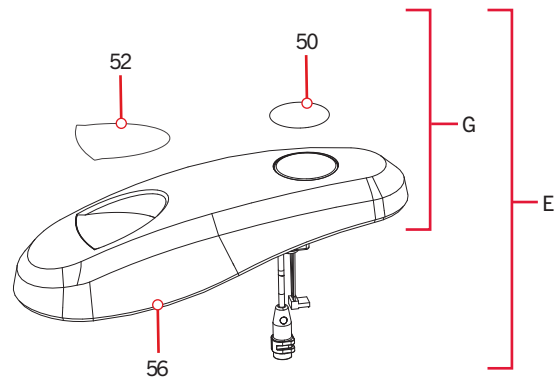
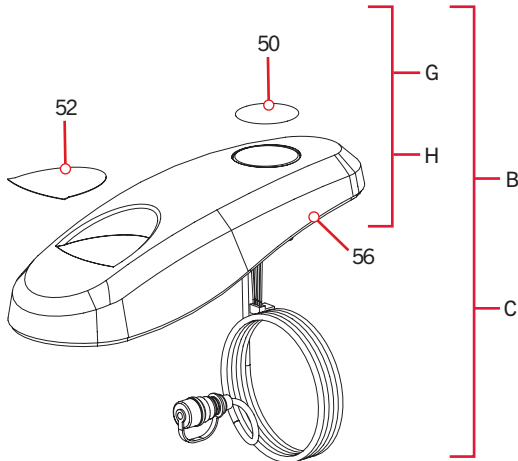

PARTS DIAGRAM & PARTS LIST

Control Head Parts List

Assembly	Part #	Description	Notes	Quantity
B	2774108	CONTROLLER, ADV GPS NAV, PD	*POWERDRIVE* *FRESHWATER*	1
C	2774109	CONTROLLER, ADV GPS NAV, RT PD	*RT POWERDRIVE* *SALTWATER*	1
D	2774103	CONTROLLER,ADV GPS NAV,TRV/UTX	*TERROVA* *ULTREX* *FRESHWATER*	1
E	2774104	MTR KIT, 4.0 PM SW WR	*RT TERROVA* *SALTWATER*	1
F	2994195	MTR KIT, 4.0 ULT1.5 FW WR	*ULTERRA* *FRESHWATER*	1
G	2770242	COV KIT, ADV GPS NAV, TRV/UTX	*COVER & DECALS ONLY* *POWERDRIVE* *TERROVA* *ULTREX* *FRESHWATER*	1
H	2770243	CVR KIT, ADV GPS NAV, RT TRV	*COVER & DECALS ONLY* *RT POWERDRIVE* *RT TERROVA* *SALTWATER*	1
Item	Part #	Description	Notes	Quantity
50	2395524	DECAL, DOMED FW	*POWERDRIVE* *TERROVA* *ULTREX* *ULTERRA* *FRESHWATER*	1
	2395529	DECAL, DOMED SW	*RT POWERDRIVE* *RT TERROVA* *SALTWATER*	1
52	2395593	DECAL, PUSH BTN TOP, SW, GENERIC	*RT POWERDRIVE* *SALTWATER*	1
	2395575	DECAL, PUSH BUTTON TOP, 45 LB, PD, FW	*45LB* *POWERDRIVE* *FRESHWATER*	1
	2395576	DECAL, PUSH BUTTON TOP, 55 LB, PD, FW	*55LB* *POWERDRIVE* *FRESHWATER*	1
	2395578	DECAL, PUSH BUTTON TOP, 55 LB, PD, SW	*55LB* *RT POWERDRIVE* *SALTWATER*	1
	2395564	DECAL,PUSH BTN TOP 55# FW	*55LB* *TERROVA* *FRESHWATER*	1
	2395567	DECAL,PUSH BTN TOP 55# SW	*55LB* *RT TERROVA* *SALTWATER*	1
	2395577	DECAL, PUSH BUTTON TOP, 70 LB, PD, FW	*70LB* *POWERDRIVE* *FRESHWATER*	1
	2395579	DECAL, PUSH BUTTON TOP, 70 LB, PD, SW	*70LB* *RT POWERDRIVE* *SALTWATER*	1
	2395565	DECAL,PUSH BTN TOP 80# FW	*80LB* *TERROVA* *FRESHWATER*	1
	2395568	DECAL,PUSH BTN TOP 80# SW	*80LB* *RT TERROVA* *SALTWATER*	1
	2395573	DECAL,PUSH BTN TOP 80 LB	*80LB* *ULTREX* *FRESHWATER*	1
	2395566	DECAL,PSH BTN TOP 112# FW	*112LB* *TERROVA* *FRESHWATER*	1
	2395569	DECAL,PSH BTN TOP 112# SW	*112LB* *RT TERROVA* *SALTWATER*	1
	2395574	DECAL,PUSH BTN TOP 112 LB	*112LB* *ULTREX* *FRESHWATER*	1
54	2395562	DECAL,PUSH BTN TOP 80 LB	*80LB* *ULTERRA* *FRESHWATER*	1
	2395563	DECAL,PUSH BTN TOP 112 LB	*112LB* *ULTERRA* *FRESHWATER*	1
56	2290212	COVER,CTRL BOX iP, PD PRINTED	*POWERDRIVE* *TERROVA* *ULTREX* *FRESHWATER*	1
	2290213	COVER, CTRL BOX RT PD PRINTED	*RT POWERDRIVE* *RT TERROVA* *SALTWATER*	1
60	2200208	CONTROL BOX COVER, FW	*ULTERRA* *FRESHWATER*	1

▲ Not shown on Parts Diagram.

✘ This part is included in an assembly and cannot be ordered individually.

PARTS DIAGRAM & PARTS LIST



» QUEST Control Head Parts Diagram

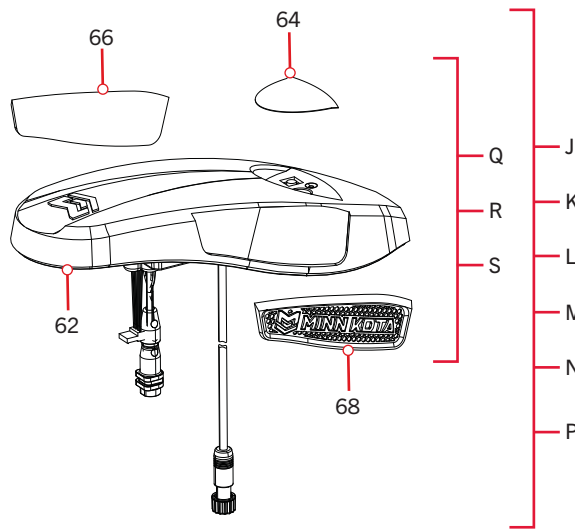

PARTS DIAGRAM & PARTS LIST

QUEST Control Head Parts List

Assembly	Part #	Description	Notes	Quantity
J	2994190	MTR KIT, 4.0 BL FW WR GND	*TERROVA QUEST* *ULTERRA QUEST* *MSI* *FRESHWATER BLACK*	1
K	2994191	MTR KIT, 4.0 BL FW MR GND	*ULTREX QUEST* *MSI* *FRESHWATER BLACK*	1
L	2994192	MTR KIT, 4.0 BL FW WR	*TERROVA QUEST* *ULTERRA QUEST* *DSC* *FRESHWATER BLACK*	1
M	2994193	MTR KIT, 4.0 BL FW MR	*ULTREX QUEST* *DSC* *FRESHWATER BLACK*	1
N	2994194	MTR KIT, 4.0 BL SW WR	*RT TERROVA QUEST* *RT INSTINCT QUEST* *SALTWATER WHITE*	1
P	2994183	MTR KIT, 4.0 BL SW-BK WR	*RT INSTINCT QUEST* *SALTWATER BLACK*	1
Q	2770247	CTRL BOX COVER QUEST FW	*COVER & DECALS ONLY* *TERROVA QUEST* *ULTREX QUEST* *ULTERRA QUEST* *FRESHWATER BLACK*	1
R	2770248	CTRL BOX COVER QUEST SW WHT	*COVER & DECALS ONLY* *RT TERROVA QUEST* *RT INSTINCT QUEST* *SALTWATER WHITE*	1
S	2770249	CTRL BOX COVER QUEST SW BLK	*COVER & DECALS ONLY* *RT INSTINCT QUEST* *SALTWATER BLACK*	1
Item	Part #	Description	Notes	Quantity
62	2200220	CONTROL BOX COVER, BLACK	*TERROVA QUEST* *ULTREX QUEST* *ULTERRA QUEST* *RT INSTINCT QUEST* *FRESHWATER BLACK* *SALTWATER BLACK*	1
	2200221	CONTROL BOX COVER, WHITE	*RT TERROVA QUEST* *RT INSTINCT QUEST* *SALTWATER WHITE*	1
64	2395560	DECAL,PUSH BTN,ULT FX,BLK	*TERROVA QUEST* *ULTREX QUEST* *ULTERRA QUEST* *FRESHWATER BLACK*	1
	2395561	DECAL,PSH BTN,INST,WHT	*RT TERROVA QUEST* *RT INSTINCT QUEST* *SALTWATER WHITE*	1
	2395595	DECAL,PUSH BTN, INSTINCT	*RT INSTINCT QUEST* *SALTWATER BLACK*	1
66	2205540	DECAL, CTRL BOX MK RIGHT FW	*TERROVA QUEST* *ULTREX QUEST* *ULTERRA QUEST* *FRESHWATER*	1
	2205541	DECAL, CTRL BOX MK RIGHT SW	*RT TERROVA QUEST* *RT INSTINCT QUEST* *SALTWATER*	1
68	2205545	DECAL, CTRL BOX MK LEFT FW	*TERROVA QUEST* *ULTREX QUEST* *ULTERRA QUEST* *FRESHWATER*	1
	2205546	DECAL, CTRL BOX MK LEFT SW	*RT TERROVA QUEST* *RT INSTINCT QUEST* *SALTWATER*	1

▲ Not shown on Parts Diagram.

✘ This part is included in an assembly and cannot be ordered individually.

RECOMMENDED ACCESSORIES

ON-BOARD & PORTABLE BATTERY CHARGERS

Stop buying new batteries and start taking care of the ones you've got. Many chargers can actually damage your battery over time – creating shorter run times and shorter overall life. Digitally controlled Minn Kota chargers are designed to provide the fastest charge that protect and extend battery life.



MK212PCL



MK210D



MK110PD

TALON SHALLOW WATER ANCHOR

Talon is the only shallow water anchor with up to 15' of anchoring depth, multiple anchoring modes, and control from the bow, transom, console, remote or mobile device.



BUILT-IN WORK LIGHT

Lets you tie lines and work from the transom any time of day — or night. Includes both white and blue LED lights with three brightness settings.



UP TO 15' DEEP

Control more water and catch more fish with the first 15' shallow water anchor.



MORE CONTROL OPTIONS

- Control Panel
- Wireless Remote
- Mobile App
- Wireless Foot Switch
- Humminbird® Connectivity
- Advanced GPS Navigation System Remote



BLUETOOTH® CONNECTIVITY

Lets you control Talon from your mobile device and easily update it. Also opens up communication to other control options.

MINN KOTA ACCESSORIES

We offer a wide variety of trolling motor accessories, including:

- 60-Amp Circuit Breaker
- Battery Connectors
- Mounting Brackets
- Battery Boxes
- Stabilizer Kits
- Quick Connect Plugs
- Extension Handles



minnkota.johnsonoutdoors.com    

Part #2397110

Minn Kota Consumer & Technical Service
Johnson Outdoors Marine Electronics, Inc.
PO Box 8129
Mankato, MN 56001

ECN 44000

121 Power Drive
Mankato, MN 56001
Phone (800) 227-6433
Fax (800) 527-4464



©2023 Johnson Outdoors Marine Electronics, Inc.
All rights reserved.

Rev A

06/23